

TAKAB ETTESAL

Plastic pipe and fittings Manufacturer Co.



Electrofusion Fittings



Injection Moulded Fittings



Flanged Joint Fittings



Polypropylene Fittings

2022

TAKAB

TECHNICAL & PRODUCTS CATALOGUE 2022

Company Profile	Профиль Компании	1
Products	Продукты	6
PE Technical Data	PE технические данные	77
PP Technical Data	PP технические данные	94



TAKAB ETTESAL Company is a leading manufacturer of polyethylene pipe and fittings for water and gas services, this company was established on 1994 in Tehran-Iran with capacity around 3700MT/Year.

TAKAB ETTESAL Company will be able to produce a wide range of injection fittings in a same time due to having 21 lines which are made up in German.

This company is supply lots of products as follow:

- Electrofusion Fittings
- Injection Moulded Fittings
- Flanged Joint Fittings
- Special Fittings (according to customer request and standard requirement)

This Company with having 4 machines in CINCINNATI brand is able to produce mono and double layer polyethylene pipe up to size 630mm.

CERTIFICATES

Laboratory Accreditation:

The Takab Ettesal lab operates in accordance to the standard ISO/IEC 17025:2005 and is accredited from NACI- Iranian accreditation body with accreditation number NACI/Lab/357. The accreditation certifies technical qualification of the laboratory relatively to the testing detailed in the enclosed sheets to the certificate. Available at the website www.naci.ir.



Quality system certification:

The Takab Ettesal quality management system involves and manages all activities within the company in order to achieve the optimum level of the quality standards. That is on the basis of the direction imposed in the ISO 9001:2015 standard which points out the requirements for the supplier to show its capability in checking the processes which determine the conformity of the finished product. The correct management of all documents allows the tracing of the product through the batch reference number or other codes assigned during the production.

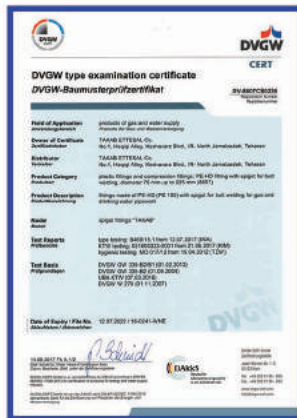

Quality product:

Takab Ettesal is authorized to use the ACM and SGS quality marking with reference to the standard ISO 4427-3 for the fittings as detailed in certificates.

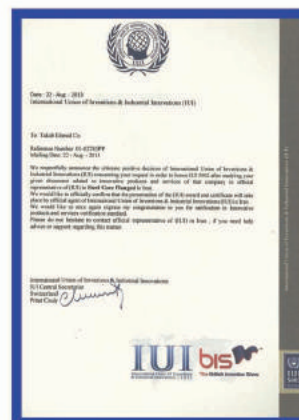

Quality Control & Laboratory:

Takab Ettesal fittings are continuously monitored throughout the entire production process in accordance with the internal testing programs in compliance with the standards EN 1555, EN 12201, ISO 4424 and INSO 14427. The testing activities are continuously carried out following up the complete observance of the reference standards and foresee tests of mechanical and physical type, either on the fittings and on the raw material.



Particularly, the production is subjected to the following tests:

- **Melt mass-flow rate (MFR)**

Ref. ISO 1133-1, 2

- **Carbon Black Content**

Ref. ISO 6964

- **Hydrostatic Strength at 20°C and 80°C**

Ref. ISO 1187

- **Oxidation Induction Time (OIT)**

Ref. ISO 11357-6

- **Tensile Standards**

Ref. ISO 13953

ISO 6259

INSO 17140

- **Density**

Ref. ISO 1183

- **Carbon Black Dispersion**

Ref. ISO 18553

- **Decohesive resistance (peel and crushing test)**

Ref. ISO 13954

ISO 13955

ISO 13956

- **Dimensional Control, Marking control**

Ref. EN 1555

EN 12201

ISO 4427

INSO 14427

- **Tensile Creep Test Standards**

Ref. EN 12814

ISO 16770

Contents

Polyethylene Pipe	6
Electrofusion Fittings	
Tapping Saddle	8
Coupler	9
Equal and Reduced Tee	10
Elbow 90°	11
Equal Tee with Coupler	12
Reduced Tee with Coupler	13
Elbow 90° with Coupler	14
Elbow 45° with Coupler	15
Reducer with Coupler	16
End Cap	18
Injection Moulded Fittings	
Flange Adaptor	20
Equal Tee	22
Reduced Tee	23
Elbow 90°	26
Elbow 45°	27
Elbow 11.25°, 22.5°, 30°	28
Concentric Reducer Long Spigot	29
Concentric Reducer Short Spigot	32
Eccentric Reducer	34
End Cap	36
Cross	37
Fabricated Fittings	
Elbow 90°	39
Elbow 45°, 60°	40
Equal Tee 90°	41
Saddle Fusion Tee	42
Equal Tee 45°, 60°	45
Cross	46
Flanged Joint Fittings	
Steel Core Hole Flange	48
Flat Face Tee	49
Flat Face Elbow 90°	52
Flat Face Reducer	53
Steel Backing Ring	55
Blind Flange	60
Polypropylene Pipe and Fittings	
Pipe	62
Flange Adaptor	63
Equal Tee	65
Reduced Tee	66
Elbow 90°	68
Elbow 45°	69
Concentric Reducer Long Spigot	70
Coupler	72
PP-Steel Backing Ring	73
Special Fittings	
TF, Paddle pipe	74
Collector	75





Polyethylene Pipe Specification DIN 8074, INSO1 4427

SDR	51	41	33	26	22	21	17	13.6	11	9	7.4	6	5	
PE80 Sf1.25	2.5	3.2	4.0	5.0	6.0	6.4(6.0)	8.0	10.0	12.5	16.0	20.0	25.0	32.0	
PE80 Sf1.6	2.0	2.5	3.0	4.0	4.6	5.0	6.3	8.0	10.0	12.5	16.0	20.0	25.0	
PE80 Sf2	1.6	2.0	2.5	3.0	3.8	4.0	5.0	6.3	8.0	10.0	12.5	16.0	20.0	
PE100 Sf1.25	3.2	4.0	5.0	6.3(6.0)	7.4	8.0	10.0	12.5	16.0	20.0	25.0	32.0	40.0	
PE100 Sf1.6	2.5	3.0	4.0	5.0	6.0	6.3	8.0	10.0	12.5	16.0	20.0	25.0	31.0	
PE100 Sf2	2.0	2.5	3.0	4.0	4.8	5.0	6.3	8.0	10.0	12.5	15.5	20.0	25.0	
Diameter (mm)	e _n mm	Mass Kg/m	e _n mm	Mass Kg/m	e _n mm	Mass Kg/m	e _n mm	Mass Kg/m	e _n mm	Mass Kg/m	e _n mm	Mass Kg/m	e _n mm	Mass Kg/m
20	-	-	-	-	-	-	-	-	2.0	0.118	2.3	0.134	3.0	0.164
25	-	-	-	-	-	-	-	2.0	0.151	2.3	0.173	3.0	0.202	3.5
32	-	-	-	-	-	-	2.0	0.198	2.4	0.235	3.0	0.282	3.6	0.331
40	-	-	-	1.8	0.229	1.9	0.240	2.0	0.251	2.3	0.288	2.4	0.299	3.0
50	-	-	1.8	0.290	2.0	0.317	2.3	0.365	2.4	0.378	2.9	0.445	3.0	0.458
63	-	1.8	0.368	2.0	0.403	2.5	0.500	2.9	0.569	3.0	0.695	3.8	0.728	4.7
75	1.8	0.440	1.9	0.462	2.3	0.557	2.9	0.683	3.5	0.816	3.6	0.836	4.3	0.987
90	1.8	0.531	2.2	0.647	2.8	0.800	3.5	0.988	4.1	1.15	4.3	1.20	5.1	1.40
110	2.2	0.795	2.7	0.952	3.4	1.19	4.2	1.45	5.0	1.69	5.3	1.79	6.3	2.10
125	2.5	1.01	3.1	1.25	3.9	1.53	4.8	1.86	5.7	2.19	6.0	2.29	7.1	2.69
140	2.8	1.26	3.5	1.56	4.3	1.90	5.4	2.35	6.4	2.75	6.7	2.86	8.0	3.37
160	3.2	1.65	4.0	2.02	4.9	2.45	6.2	3.08	7.3	3.58	7.7	3.75	9.1	4.40
180	3.6	2.07	4.4	2.51	5.5	3.10	6.9	3.83	8.2	4.52	8.6	4.71	10.2	5.54
200	3.9	2.48	4.9	3.08	6.2	3.88	7.7	4.74	9.1	5.57	9.6	5.84	11.4	6.86
225	4.4	3.16	5.5	3.90	6.9	4.82	8.6	5.96	10.3	7.07	10.8	7.37	12.8	8.64
250	4.9	3.88	6.2	4.88	7.7	5.98	9.6	7.38	11.4	8.68	11.9	9.02	14.2	10.7
280	5.5	4.88	6.9	6.04	8.6	7.47	10.7	9.20	12.8	10.9	13.4	11.4	15.9	13.3
315	6.2	6.18	7.7	7.59	9.7	9.47	12.1	11.7	14.4	13.8	15.0	14.3	17.9	16.9
355	7.0	7.81	8.7	9.65	10.9	12.0	13.6	14.8	16.2	17.5	16.9	18.2	20.1	21.4
400	7.9	9.92	9.8	12.2	12.3	15.2	15.3	18.8	18.2	22.1	19.1	23.1	22.7	27.2
450	8.8	12.4	11.0	15.4	13.8	19.2	17.2	23.7	20.5	28.0	21.5	29.3	25.5	34.3
500	9.8	15.4	12.3	19.2	15.3	23.6	19.1	29.2	22.8	34.5	23.9	36.1	28.3	42.3
560	11.0	19.3	13.7	23.9	17.2	29.7	21.4	36.6	25.5	43.2	26.7	45.2	31.7	53.0
630	12.3	24.3	15.4	30.2	19.3	37.5	24.1	46.4	28.7	54.7	30.0	57.0	35.7	67.2

TAKAB ETTESAL
Plastic pipe and fittings Manufacturer Co.

Electrofusion Fittings



Tapping Tee with Rotatable 360 degree outlet электросварные Седелка

Anbohrschelle, mit 360°
drehbarem Abgang

ISO 4427 | INSO 14427 | HDPE 100

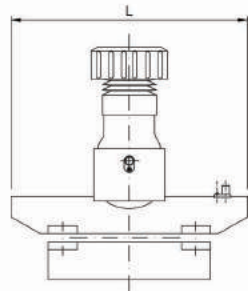
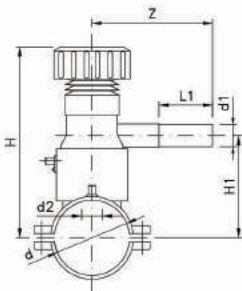

Nominal size (mm)	Code	d2 (mm)	H (mm)	H1 (mm)	L (mm)	L1 (mm)	Z (mm)
63×25	SD10602B y	32	186	108	165	71	130
63×32	SD10603B y	32	186	108	165	76	130
63×40	SD10604B y	32	186	108	165	81	137
63×50	SD10605B y	32	186	108	165	86	137
63×63	SD10606B y	32	134	112	165	100	160
90×25	SD10802B y	32	199	121	165	71	130
90×32	SD10803B y	32	199	121	165	76	130
90×40	SD10804B y	32	199	121	165	81	137
90×50	SD10805B y	32	199	121	165	86	137
90×63	SD10806B y	32	248	126	165	100	160
110×25	SD10902B y	32	209	131	165	71	130
110×32	SD10903B y	32	209	131	165	76	130
110×40	SD10904B y	32	209	131	165	81	137
110×50	SD10905B y	32	209	131	165	86	137
110×63	SD10906B y	35	258	136	165	100	160
160×25	SD11202B y	32	243	156	165	71	130
160×32	SD11203B y	32	243	156	165	76	130
160×40	SD11204B y	32	243	156	165	81	137
160×50	SD11205B y	32	243	156	165	86	137
160×63	SD11206B y	35	283	161	165	100	160
200×25	SD11402B y	32	254	176	165	71	130
200×32	SD11403B y	32	254	176	165	76	130
200×40	SD11404B y	32	254	176	165	81	137
200×50	SD11405B y	32	254	176	165	86	137
200×63	SD11406B y	35	303	181	165	100	160

• Consider y of product code as follow:

SDR	11	17
y	4	6

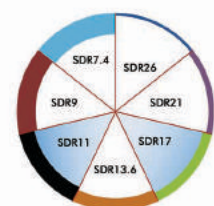

Electrofusion Coupler Электросварные Муфты

Heizwendel-Schweißmuffe

ISO 4427 | INSO 14427 | HDPE 100

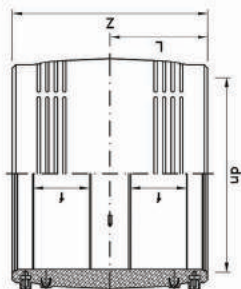

Nominal size (mm)	Code	L (mm)	f (mm)	Z (mm)
*20	CU10101B y	41	10	82
*25	CU10202B y	41	10	82
*32	CU10303B y	44	10	88
*40	CU10404B y	49	10	98
*50	CU10505B y	55	10	110
63	CU10606B y	47	17	95
75	CU10707B y	53	21	106
90	CU10808B y	61	29	123
110	CU10909B y	72	36	144
125	CU11010B y	78	39	157
160	CU11212B y	89	51	178
180	CU11313B y	103	57	206
200	CU11414B y	103	57	206
225	CU11515B y	112	62	224
250	CU11616B y	117	61	234
315	CU11818B y	126	71	253
355	CU11919B y	170	100	340
400	CU12020B y	190	120	380

*Future product

• Consider y of product code as follow:

SDR	7.4	9	11	17
y	2	3	4	6

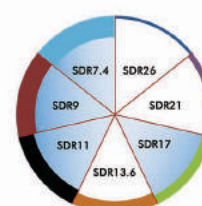

Electrofusion Equal and Reduced Tee 90° Электросварные Равные и редукционный Тройники 90°

Heizwendelschweißung-
T-Stück und T-Stück reduziert

ISO 4427 | INSO 14427 | HDPE 100

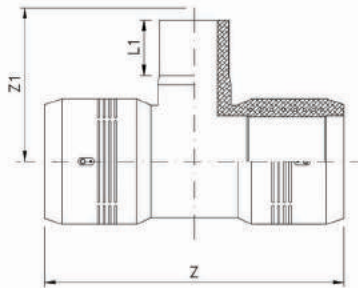

Nominal size (mm)	Code	Z (mm)	Z ₁ (mm)	L ₁ (mm)
63 × 63	F230606B y	158	114	69
75 × 63	F230706B y	213	154	92
75 × 75	F230707B y	213	154	92
90 × 63	F230806B y	213	154	92
90 × 75	F230807B y	213	154	92
90 × 90	F230808B y	213	154	92
110 × 63	F230906B y	256	191	114
110 × 75	F230907B y	256	191	114
110 × 90	F230908B y	256	191	114
110 × 110	F230909B y	256	191	114
160 × 63	F231206B y	337	170	69
160 × 75	F231207B y	337	170	69
160 × 90	F231208B y	337	193	92
160 × 110	F231209B y	337	215	114
160 × 160	F231212B y	337	213	108
200 × 63	F231406B y	420	197	69
200 × 75	F231407B y	420	197	69
200 × 90	F231408B y	420	220	92
200 × 110	F231409B y	420	242	114
200 × 200	F231414B y	420	259	125

• Consider y of product code as follow:

SDR	11	17
y	4	6

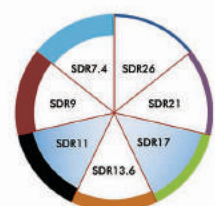

Electrofusion Elbow 90°

Электросварные Отвод 90°

ISO 4427 | INSO 14427 | HDPE 100

Heizwendelschweißung
-Winkel 90°

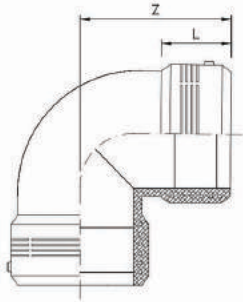

Nominal size (mm)	Code	Z (mm)	L (mm)
63	F240606B y	80	46
75	F240707B y	100	52
90	F240808B y	117	62
110	F240909B y	140	72
125	F241010B y	170	78
160	F241212B y	190	92
200	F241414B y	220	104

• Consider y of product code as follow:

SDR	11	17
y	4	6

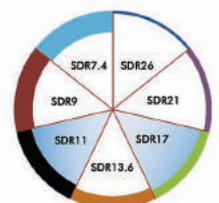

Electrofusion Equal Tee 90°

Электросварные Равные Тройники 90°

ISO 4427 | INSO 14427 | HDPE 100

Heizwendelschweißung
- T-Stück

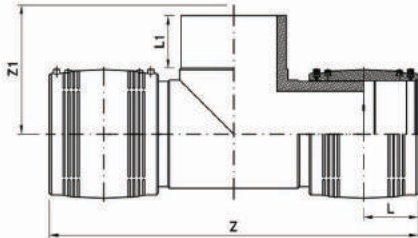

Nominal size (mm)	code	Z (mm)	Z1 (mm)	L1 (mm)	L (mm)
40	F050404 xy	250	96	38	49
50	F050505 xy	318	106	59	55
63	F050606 xy	316	115	66	47
75	F050707 xy	350	129	71	52
90	F050808 xy	393	143	70	61
110	F050909 xy	460	167	85	71
125	F051010 xy	491	168	90	78
160	F051212 xy	576	200	101	88
200	F051414 xy	648	239	108	100
225	F051515 xy	674	262	102	110
250	F051616 xy	747	282	100	115
315	F051818 xy	855	323	92	130
355	F051919 xy	990	326	125	170
400	F052020 xy	1025	325	125	190

• Consider x and y of product code as follow:

	PE100-Black		PE100-Natural	
x	B		C	
SDR	7.4	9	11	17
y	2	3	4	6

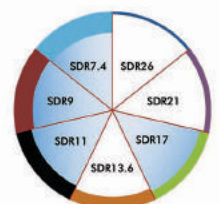

Electrofusion Reduced Tee 90°

Электросварные редукционный Тройники 90°

Heizwendelschweißung
- T-Stück reduziert

ISO 4427 | INSO 14427 | HDPE 100

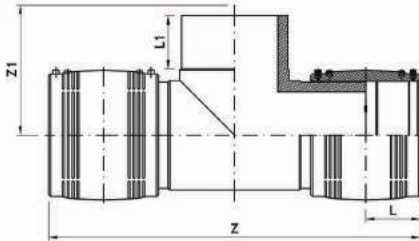

Nominal Size (mm)	Code	Z (mm)	Z1 (mm)	L1 (mm)	L (mm)
63 x 50	F050605 xy	311	105	63	47
75 x 50	F050705 xy	355	133	63	53
75 x 63	F050706 xy	354	126	66	53
90 x 63	F050806 xy	393	133	67	61
90 x 75	F050807 xy	389	128	70	61
110 x 63	F050906 xy	460	168	66	71
110 x 75	F050907 xy	462	159	72	71
110 x 90	F050908 xy	460	155	80	71
125 x 63	F051006 xy	492	166	66	78
125 x 75	F050707 xy	491	167	71	78
125 x 90	F051007 xy	488	163	81	78
160 x 63	F051206 xy	584	198	67	88
160 x 75	F051207 xy	580	197	67	88
160 x 90	F051208 xy	577	202	85	88
160 x 110	F051209 xy	584	205	90	88
200 x 75	F051407 xy	576	195	75	103
200 x 90	F051408 xy	655	227	83	103
200 x 110	F051409 xy	655	225	87	103
200 x 160	F051412 xy	574	201	83	103
225 x 63	F051506 xy	674	262	102	110
225 x 90	F051508 xy	674	262	102	110
225 x 110	F051509 xy	674	262	102	110
225 x 160	F051512 xy	674	262	102	110
250 x 90	F051608 xy	581	204	88	103
250 x 110	F051609 xy	640	220	72	100
250 x 160	F051612 xy	648	228	83	100
250 x 200	F051614 xy	635	215	79	100

• Consider x and y of product code as follow:

	PE100-Black		PE100-Natural	
x	B		C	
SDR	7.4	9	11	17
y	2	3	4	6

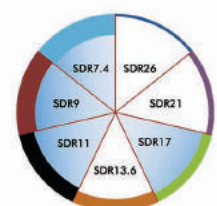

Electrofusion Elbow 90°

Электросварные Отвод 90°

ISO 4427 | INSO 14427 | HDPE 100

Heizwendelschweißung
-Winkel 90°

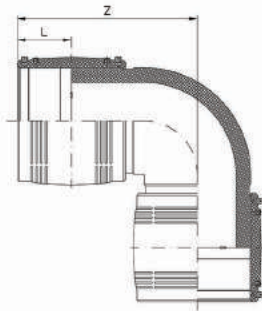

Nominal size (mm)	Code	Z (mm)	L (mm)
40	F020404 xy	129	49
50	F020505 xy	165	55
63	F020606 xy	159	47
75	F020707 xy	172	52
90	F020808 xy	188	61
110	F020909 xy	224	71
125	F021010 xy	250	78
160	F021212 xy	288	88
200	F021414 xy	348	100
225	F021515 xy	353	110
250	F021616 xy	365	115
315	F021818 xy	459	130
355	F021919 xy	498	170
400	F022020 xy	515	190

• Consider x and y of product code as follow:

	PE100-Black		PE100-Natural	
x	B		C	
SDR	7.4	9	11	17
y	2	3	4	6

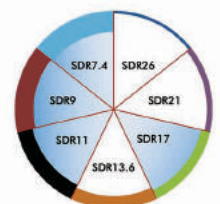

Electrofusion Elbow 45° Электросварные Отвод 45°

ISO 4427 | INSO 14427 | HDPE 100

Heizwendelschweißung
-Winkel 45°

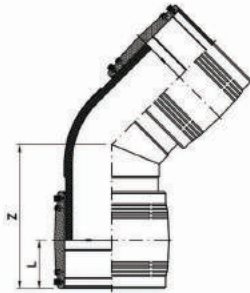

Nominal size (mm)	Code	Z (mm)	L (mm)
40	F010404 xy	129	49
50	F010505 xy	165	55
63	F010606 xy	141	47
75	F010707 xy	157	52
90	F010808 xy	181	61
110	F010909 xy	192	71
125	F011010 xy	208	78
160	F011212 xy	236	88
200	F011414 xy	280	100
225	F011515 xy	294	110
250	F011616 xy	325	115
315	F011818 xy	336	130
400	F012020 xy	417	190

• Consider x and y of product code as follow:

	PE100-Black		PE100-Natural	
x	B		C	
SDR	7.4	9	11	17
y	2	3	4	6

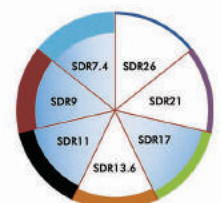

Electrofusion Reducer

Электросварные Переходник

ISO 4427 | INSO 14427 | HDPE 100

Heizwendelschweißung
- Reduktion konzentrische

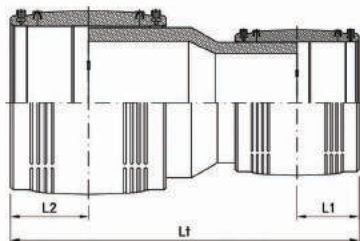

Nominal size (mm)	Code	Lt (mm)	L1 (mm)	L2 (mm)
63×40	F130604 xy	229	49	47
63×50	F130605 xy	233	55	47
75×40	F130704 xy	250	49	53
75×50	F130705 xy	256	55	53
75×63	F130706 xy	243	47	52
90×63	F130806 xy	247	47	61
90×75	F130807 xy	265	52	61
110×63	F130906 xy	286	47	71
110×75	F130907 xy	290	52	71
110×90	F130908 xy	299	61	71
125×63	F131006 xy	283	47	78
125×90	F131008 xy	349	61	78
125×110	F131009 xy	300	71	78
160×63	F131206 xy	347	47	88
160×75	F131207 xy	353	53	88
160×90	F131208 xy	361	61	88
160×110	F131209 xy	386	71	88
160×125	F131210 xy	381	78	88
200×63	F131406 xy	413	47	103
200×75	F131407 xy	419	53	103
200×90	F131408 xy	427	61	103
200×110	F131409 xy	419	71	103
200×125	F131410 xy	428	78	103
200×160	F131412 xy	471	88	103

• Consider x and y of product code as follow:

	PE100-Black		PE100-Natural	
x	B		C	
SDR	7.4	9	11	17
y	2	3	4	6

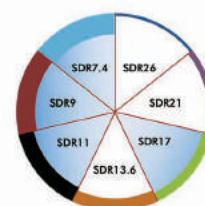

Electrofusion Reducer

Электросварные Переходник

ISO 4427 | INSO 14427 | HDPE 100

Heizwendelschweißung
- Reduktion konzentrische

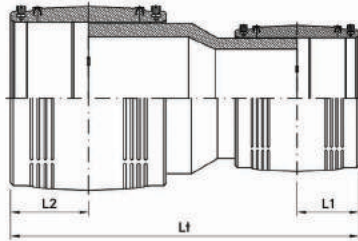

Nominal size (mm)	Code	Lt (mm)	L1 (mm)	L2 (mm)
225×63	F131506 xy	492	47	112
225×75	F131507 xy	492	52	112
225×90	F131508 xy	492	61	112
225×110	F131509 xy	492	71	112
225×125	F131510 xy	492	78	112
225×160	F131511 xy	492	88	112
225×200	F131512 xy	492	103	112
250×90	F131608 xy	463	61	117
250×110	F131609 xy	471	71	115
250×160	F131612 xy	497	88	115
250×200	F131614 xy	502	100	115
315×160	F131812 xy	700	88	126
315×200	F131814 xy	619	103	126
315×250	F131816 xy	633	117	126
400×160	F132012 xy	734	89	190
400×200	F132014 xy	763	103	190

• Consider x and y of product code as follow:

	PE100-Black				PE100-Natural
x	B				C
SDR	7.4	9	11	17	
y	2	3	4	6	

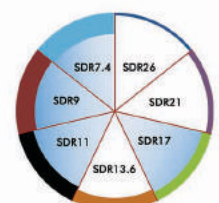

Electrofusion Cap

Электросварные Заглушка

Heizwendelschweißung
-Endkappe

ISO 4427 | INSO 14427 | HDPE 100

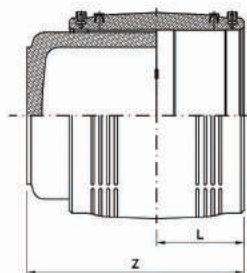

Nominal size (mm)	Code	Z (mm)	L (mm)
40	F140404 xy	111	49
50	F140505 xy	118	55
63	F140606 xy	112	47
75	F140707 xy	130	52
90	F140808 xy	149	61
110	F140909 xy	162	71
125	F141010 xy	178	78
160	F141212 xy	210	88
200	F141414 xy	235	100
225	F141515 xy	278	112
250	F141616 xy	252	117
315	F141818 xy	376	126
355	F141919 xy	420	170
400	F142020 xy	440	190

• Consider x and y of product code as follow:

	PE100-Black		PE100-Natural	
x	B		C	
SDR	7.4	9	11	17
y	2	3	4	6

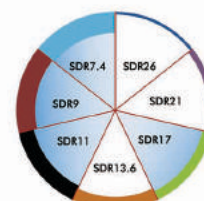

TAKAB ETTESAL
Plastic pipe and fittings Manufacturer Co.

Injection Moulded Fittings



Flange Adaptor(Type A)

Литые Фланцы

Vorschweißbund (Typ A)

ISO 4427 | INSO 14427 | HDPE 100

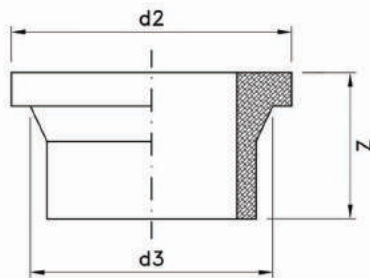

Nominal size (mm)	Code		d ₂ (mm)	d ₃ (mm)	Z (mm)	
	Normal	Long			Normal	Long
32	FL10303 xy	FL20303 xy	68	40	-	85
40	FL10404 xy	FL20404 xy	78	50	-	85
50	FL10505 xy	FL20505 xy	88	61	-	85
63	FL10606 xy	FL20606 xy	102	75	92	95
75	FL10707 xy	FL20707 xy	122	89	110	120
90	FL10808 xy	FL20808 xy	138	105	125	140
110	FL10909 xy	FL20909 xy	158	125	120	160
125	FL11010 xy	FL21010 xy	158	132	120	170
140	FL11111 xy	FL21111 xy	188	155	152	200
160	FL11212 xy	FL21212 xy	212	175	155	200
180	FL11313 xy	FL21313 xy	212	180	171	199
200	FL11414 xy	FL21414 xy	268	232	193	199
225	FL11515 xy	FL21515 xy	268	235	200	200
250	FL11616 xy	FL21616 xy	320	285	204	204
280	FL11717 xy	FL21717 xy	320	291	171	210
315	FL11818 xy	FL21818 xy	370	335	173	210
355	FL11919 xy	FL21919 xy	430	373	181	210
400	FL12020 xy	FL22020 xy	482	427	150	-
450	FL12121 xy	FL22121 xy	585	514	150	-
500	FL12222 xy	FL22222 xy	585	530	150	-
560	FL12323 xy	FL22323 xy	685	615	150	-
630	FL12424 xy	FL22424 xy	685	642	250	-
710	FL12525 xy	FL22525 xy	800	737	250	-
800	FL12626 xy	FL22626 xy	905	840	270	-
900	FL12727 xy	FL22727 xy	1005	944	280	-
1000	FL12828 xy	FL22828 xy	1110	1047	290	-

length tolerance: ±(2-5 mm)

• Consider x and y of product code as follow:

		PE100-Black				PE100-Natural			
x		B				C			
SDR		7.4	9	11	13.6	17	21	26	
y		2	3	4	5	6	7	8	

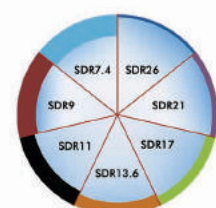

Flange Adaptor(Type B)

Литые Фланцы

Vorschweißbund (Typ B)

ISO 4427 | INSO 14427 | HDPE 100

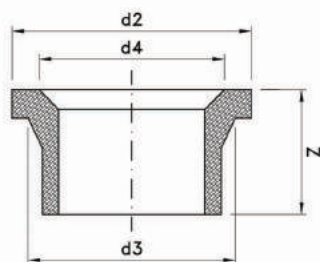

Nominal size (mm)	Code		d ₂ (mm)	d ₃ (mm)	d ₄ (mm)	Z (mm)	
	Normal	Long				Normal	Long
63	FL30606 xy	FL40606 xy	102	75	60	92	95
75	FL30707 xy	FL40707 xy	122	89	66	110	120
90	FL30808 xy	FL40808 xy	138	105	78	125	140
110	FL30909 xy	FL40909 xy	158	125	100	120	160
125	FL31010 xy	FL41010 xy	158	132	114	120	170
140	FL31111 xy	FL41111 xy	188	155	127	152	200
160	FL31212 xy	FL41212 xy	212	175	151	155	200
180	FL31313 xy	FL41313 xy	212	180	158	171	199
200	FL31414 xy	FL41414 xy	268	232	203	193	199
225	FL31515 xy	FL41515 xy	268	235	210	200	200
250	FL31616 xy	FL41616 xy	320	285	245	204	204
280	FL31717 xy	FL41717 xy	320	291	265	171	210
315	FL31818 xy	FL41818 xy	370	335	300	173	210
355	FL31919 xy	FL41919 xy	430	373	-	181	210
400	FL32020 xy	FL42020 xy	482	427	-	150	-
450	FL32121 xy	FL42121 xy	585	514	-	150	-
500	FL32222 xy	FL42222 xy	585	530	-	150	-

TYPE B: With chamfer suitable for butterfly valve according to ISO 5752, API 609
length tolerance: ±(2-5 mm)

• Consider x and y of product code as follow:

		PE100-Black				PE100-Natural			
x		B				C			
SDR		7.4	9	11	13.6	17	21	26	
y		2	3	4	5	6	7	8	

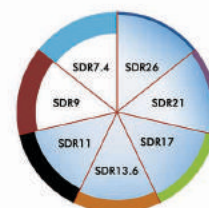

Equal Tee 90°

Литые Тройники Соединительные 90°

T-Stück 90°

ISO 4427 | INSO 14427 | HDPE 100

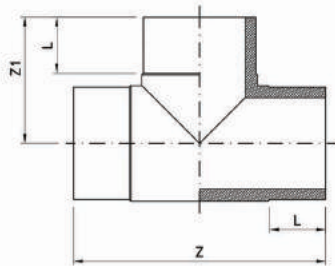

Nominal size (mm)	Code	Z (mm)	Z ₁ (mm)	L (mm)
32	T010303 xy	133	81	28
40	T010404 xy	151	96	38
50	T010505 xy	208	108	59
63	T010606 xy	221	106	60
75	T010707 xy	248	124	72
90	T010808 xy	247	136	70
110	T010909 xy	317	159	85
125	T011010 xy	290	147	67
140	T011111 xy	375	194	35
160	T011212 xy	400	200	102
180	T011313 xy	466	234	107
200	T011414 xy	450	239	108
225	T011515 xy	454	262	102
250	T011616 xy	517	282	101
280	T011717 xy	601	324	101
315	T011818 xy	596	299	125
355	T011919 xy	651	326	125
400	T012020 xy	645	325	125
*450	T012121 xy	970	511	201
500	T012222 xy	970	511	201

* Only SDR21

- Producing up to size 315mm with SDR 9 and SDR7.4
length tolerance: ±(2-5 mm)

• Consider x and y of product code as follow:

		PE100-Black				PE100-Natural		
x		B				C		
SDR		7.4	9	11	13.6	17	21	26
y		2	3	4	5	6	7	8

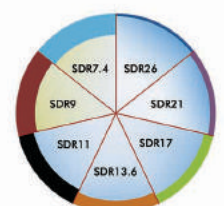

Reduced Tee 90°

Литые Тройники Переходные 90°

T-Stück 90° reduziert

ISO 4427 | INSO 14427 | HDPE 100

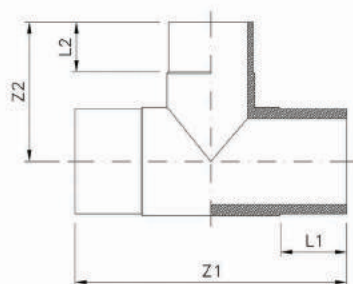

Nominal size (mm)	Code	L ₁ (mm)	L ₂ (mm)	Z ₁ (mm)	Z ₂ (mm)
63 × 32	T010603 xy	65	49	216	105
63 × 40	T010604 xy	65	49	216	105
63 × 50	T010605 xy	67	63	216	105
75 × 40	T010704 xy	73	50	249	119
75 × 50	T010705 xy	71	63	250	133
75 × 63	T010706 xy	72	65	245	120
90 × 50	T010805 xy	71	66	275	131
90 × 63	T010806 xy	72	67	271	128
90 × 75	T010807 xy	69	70	267	168
110 × 50	T010905 xy	86	65	318	157
110 × 63	T010906 xy	87	67	318	168
110 × 75	T010907 xy	81	72	320	159
110 × 90	T010908 xy	86	80	319	156
125 × 50	T011005 xy	90	72	337	167
125 × 63	T011006 xy	90	65	340	165
125 × 75	T011007 xy	89	66	337	167
125 × 90	T011008 xy	89	81	332	163
125 × 110	T011009 xy	91	82	341	169
140 × 75	T011107 xy	83	90	380	185
140 × 90	T011108 xy	83	90	380	185
140 × 110	T011109 xy	85	90	380	187
140 × 125	T011110 xy	85	90	380	187

- Producing up to size 315mm with SDR 9 and SDR7.4
length tolerance: ±(2-5 mm)

- Consider x and y of product code as follow:

		PE100-Black				PE100-Natural			
x		B				C			
SDR		7.4	9	11	13.6	17	21	26	
y		2	3	4	5	6	7	8	

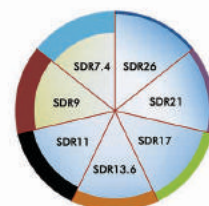

Reduced Tee 90°

Литые Тройники Переходные 90°

T-Stück 90° reduziert

ISO 4427 | INSO 14427 | HDPE 100

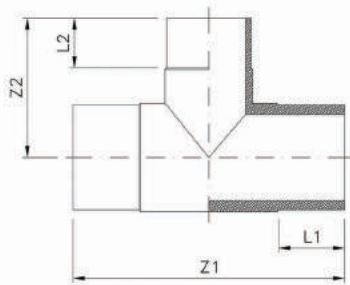

Nominal size (mm)	Code	L ₁ (mm)	L ₂ (mm)	Z ₁ (mm)	Z ₂ (mm)
160×63	T011206 xy	102	67	406	198
160×75	T011207 xy	98	76	402	196
160×90	T011208 xy	102	85	399	202
160×110	T011209 xy	104	90	406	205
160×125	T011210 xy	103	92	407	201
180×63	T011306 xy	108	51	445	207
180×90	T011308 xy	108	53	428	260
180×110	T011309 xy	110	82	440	217
180×160	T011312 xy	105	105	440	214
200×63	T011406 xy	116	75	440	225
200×75	T011407 xy	116	72	443	290
200×90	T011408 xy	118	83	450	227
200×110	T011409 xy	116	87	448	225
200×125	T011410 xy	117	91	450	228
200×160	T011412 xy	116	102	405	225
225×63	T011506 xy	120	110	530	260
225×75	T011507 xy	120	110	530	260
225×90	T011508 xy	120	110	530	260
225×110	T011509 xy	120	110	530	260
225×125	T011510 xy	120	110	530	260
225×160	T011512 xy	120	110	530	260
250×63	T011606 xy	101	90	518	355
250×90	T011608 xy	102	79	519	263
250×110	T011609 xy	104	82	520	262
250×125	T011610 xy	100	90	515	270
250×160	T011612 xy	102	99	523	265
250×200	T011614 xy	105	116	515	268

• Producing up to size 315mm with SDR 9 and SDR7.4
length tolerance: ±(2-5 mm)

• Consider x and y of product code as follow:

		PE100-Black				PE100-Natural			
x		B				C			
SDR		7.4	9	11	13.6	17	21	26	
y		2	3	4	5	6	7	8	

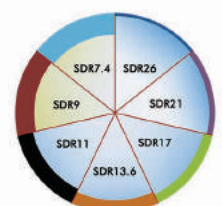

Reduced Tee 90°

Литые Тройники Переходные 90°

T-Stück 90° reduziert

ISO 4427 | INSO 14427 | HDPE 100

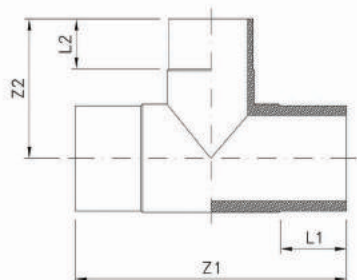

Nominal size (mm)	Code	L ₁ (mm)	L ₂ (mm)	Z ₁ (mm)	Z ₂ (mm)
315×90	T011608 xy	92	93	596	296
315×110	T011809 xy	118	137	590	302
315×125	T011810 xy	92	92	595	296
315×160	T011812 xy	93	90	590	287
315×200	T011814 xy	91	93	600	300
315×225	T011815 xy	91	90	600	290
315×250	T011816 xy	117	94	595	300
355×90	T011908 xy	119	87	646	278
355×110	T011909 xy	120	88	647	280
355×125	T011910 xy	119	102	648	286
355×160	T011912 xy	118	114	650	308
355×200	T011914 xy	119	117	645	332
355×225	T011915 xy	119	116	645	333
355×250	T011916 xy	120	115	645	332
400×160	T012012 xy	101	103	645	324
400×200	T012014 xy	115	102	670	327
400×250	T012016 xy	113	100	670	330
400×315	T012018 xy	120	112	670	350
500×200	T012214 xy	122	123	788	401
500×225	T012215 xy	123	114	770	389
500×250	T012216 xy	120	115	780	390
500×315	T012218 xy	118	118	770	315

• Producing up to size 315mm with SDR 9 and SDR7.4
length tolerance: ±(2-5 mm)

• Consider x and y of product code as follow:

		PE100-Black				PE100-Natural		
x		B				C		
SDR		7.4	9	11	13.6	17	21	26
y		2	3	4	5	6	7	8

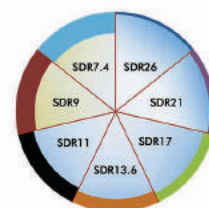

Elbow 90°

Литые Отвод 90°

Winkel 90°

ISO 4427 | INSO 14427 | HDPE 100

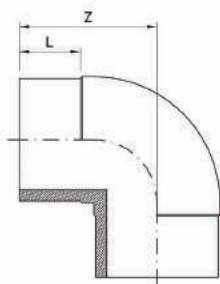

Nominal size (mm)	Code	Z (mm)	L (mm)
32	E020303 xy	72	45
40	E020404 xy	80	50
50	E020505 xy	110	63
63	E020606 xy	117	61
75	E020707 xy	120	60.3
90	E020808 xy	128	54.9
110	E020909 xy	158	86
125	E021010 xy	172	85
140	E021111 xy	174	87
160	E021212 xy	179	102
180	E021313 xy	247	129
200	E021414 xy	244	120
225	E021515 xy	242	113
250	E021616 xy	248	103
315	E021818 xy	327	122
355	E021919 xy	328	123
400	E022020 xy	325	122
*450	E022121 xy	382	123
500	E022222 xy	381	122

* Future Product

• Producing up to size 315 mm with SDR 9 and SDR7.4

length tolerance: ±(2-5 mm)

• Consider x and y of product code as follow:

		PE100-Black				PE100-Natural			
x		B				C			
SDR		7.4	9	11	13.6	17	21	26	
y		2	3	4	5	6	7	8	

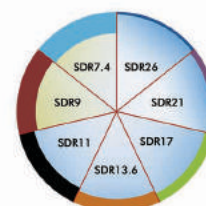

Elbow 45°

Литые Отвод 45°

ISO 4427 | INSO 14427 | HDPE 100

Winkel 45°

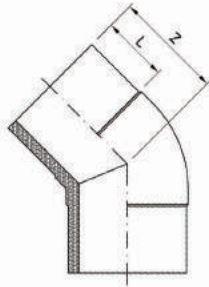

Nominal size (mm)	Code	Z (mm)	L (mm)
40	E010404 xy	80	49
50	E010505 xy	110	60
63	E010606 xy	92	59
75	E010707 xy	97	60
90	E010808 xy	102	78
110	E010909 xy	118	84
125	E011010 xy	125	88
160	E011212 xy	138	86
180	E011313 xy	149	106
200	E011414 xy	179	117
225	E011515 xy	184	111
250	E011616 xy	210	128
315	E011818 xy	206	120
400	E012020 xy	227	120

- Producing up to size 315 mm with SDR 9 and SDR7.4
length tolerance: $\pm(2-5 \text{ mm})$

- Consider x and y of product code as follow:

x	PE100-Black				PE100-Natural			
	B				C			
SDR	7.4	9	11	13.6	17	21	26	
y	2	3	4	5	6	7	8	

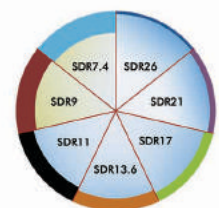

Elbow 11.25°, 22.5°, 30°

Литые Отвод 11.25°, 22.5°, 30°

Winkel 11.25°, 22.5°, 30°

ISO 4427 | INSO 14427 | HDPE 100

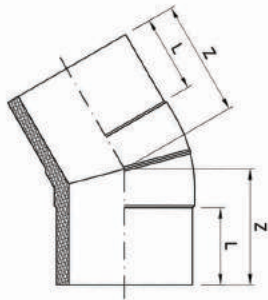

Nominal size (mm)	Code			Z _{min} (mm)	L (mm)
	11.25°	22.5°	30°		
40	E220404 xy	E230404 xy	E240404 xy	90	58
50	E220505 xy	E230505 xy	E240505 xy	90	58
63	E220606 xy	E230606 xy	E240606 xy	95	60
75	E220707 xy	E230707 xy	E240707 xy	110	79
90	E220808 xy	E230808 xy	E240808 xy	95	85
110	E220909 xy	E230909 xy	E240909 xy	130	88
125	E221010 xy	E231010 xy	E241010 xy	140	85
160	E221212 xy	E231212 xy	E241212 xy	160	106
180	E221313 xy	E231313 xy	E241313 xy	170	117
200	E221414 xy	E231414 xy	E241414 xy	185	111
225	E221515 xy	E231515 xy	E241515 xy	200	128
250	E221616 xy	E231616 xy	E241616 xy	230	102
315	E221818 xy	E231818 xy	E241818 xy	210	120
355	E221919 xy	E231919 xy	E241919 xy	220	115
400	E222020 xy	E232020 xy	E242020 xy	210	118

• Producing up to size 315 mm with SDR 9 and SDR7.4
length tolerance: ±(2-5 mm)

• Consider x and y of product code as follow:

		PE100-Black				PE100-Natural			
x		B				C			
SDR		7.4	9	11	13.6	17	21	26	
y		2	3	4	5	6	7	8	

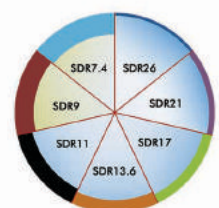

Concentric Reducer Long spigot

Литые Одноступенчатые Переходники

Reduktion konzentrische,
lange Schenkel

ISO 4427 | INSO 14427 | HDPE 100

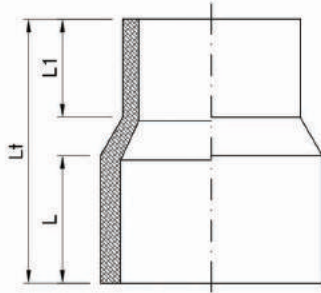

Nominal size (mm)	Code	L ₁ (mm)	L (mm)	L _t (mm)
32×20	R010301 xy	45	41	118
32×25	R010302 xy	45	41	118
40×25	R010402 xy	45	41	118
40×32	R010403 xy	45	50	125
50×25	R010502 xy	48	59	134
50×32	R010503 xy	48	58	125
50×40	R010504 xy	51	62	129
63×20	R010601 xy	30	61	131
63×25	R010602 xy	43	61	132
63×32	R010603 xy	40	60	142
63×40	R010604 xy	49	57	133
63×50	R010605 xy	56	55	131
75×40	R010704 xy	46	67	148
75×50	R010705 xy	55	66	148
75×63	R010706 xy	58	67	143
90×63	R010806 xy	51	71	139
90×75	R010807 xy	64	69	151
110×20	R010901 xy	41	77	151
110×32	R010903 xy	42	78	155
110×63	R010906 xy	54	77	167
110×75	R010907 xy	64	82	167
110×90	R010908 xy	64	91	210
125×63	R011006 xy	54	85	158
125×75	R011007 xy	77	91	214
125×90	R011008 xy	77	91	214
125×110	R011009 xy	63	74	152

• Producing up to size 315mm with SDR 9 and SDR7.4
length tolerance: ±(2-5 mm)

Producing other sizes that are not mentioned above is possible

• Consider x and y of product code as follow:

		PE100-Black				PE100-Natural			
x		B				C			
SDR		7.4	9	11	13.6	17	21	26	
y		2	3	4	5	6	7	8	

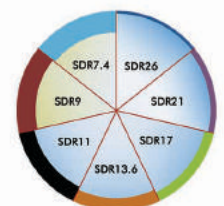

Concentric Reducer Long spigot

Литые Одноступенчатые Переходники

Reduktion konzentrische,
lange Schenkel

ISO 4427 | INSO 14427 | HDPE 100

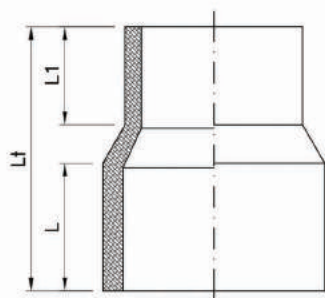

Nominal size (mm)	Code	L ₁ (mm)	L (mm)	L _t (mm)
160×63	R011206 xy	87	76	212
160×75	R011207 xy	87	76	212
160×90	R011208 xy	87	76	212
160×110	R011209 xy	83	101	151
160×125	R011210 xy	70	94	227
180×90	R011308 xy	70	95	236
180×110	R011309 xy	86	112	265
180×125	R011310 xy	86	112	265
180×140	R011311 xy	87	133	285
180×160	R011312 xy	79	112	245
200×63	R011406 xy	82	112	263
200×75	R011407 xy	82	112	263
200×90	R011408 xy	82	112	263
200×110	R011409 xy	85	114	260
200×125	R011410 xy	88	101	248
200×140	R011411 xy	88	133	285
200×160	R011412 xy	88	133	285
200×180	R011413 xy	88	133	285
225×63	R011506 xy	80	115	287
225×75	R011507 xy	80	115	287
225×90	R011508 xy	80	115	287
225×110	R011509 xy	80	115	287
225×125	R011510 xy	80	115	287
225×140	R011511 xy	80	115	287

• Producing up to size 315mm with SDR 9 and SDR7.4

length tolerance: ±(2-5 mm)

Producing other sizes that are not mentioned above is possible

• Consider x and y of product code as follow:

PE100-Black				PE100-Natural			
x	B			C			
SDR	7.4	9	11	13.6	17	21	26
y	2	3	4	5	6	7	8

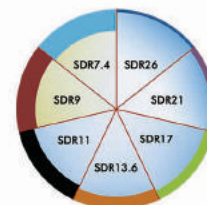

Concentric Reducer Long spigot

Литые Одноступенчатые Переходники

Reduktion konzentrische,
lange Schenkel

ISO 4427 | INSO 14427 | HDPE 100

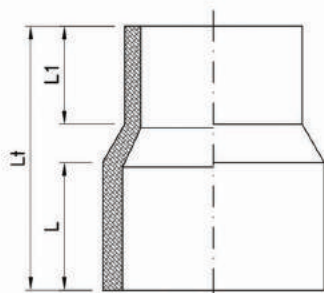

Nominal size (mm)	Code	L ₁ (mm)	L (mm)	L _t (mm)
225×160	R011512 xy	80	115	287
225×180	R011513 xy	91	142	286
225×200	R011514 xy	91	142	286
250 ×90	R011608 xy	85	120	285
250×110	R011609 xy	85	120	285
250×160	R011612 xy	80	115	287
250×180	R011613 xy	96	126	299
250×200	R011614 xy	91	142	286
315×160	R011812 xy	95	150	486
315×200	R011814 xy	96	154	390
315×250	R011816 xy	96	154	390
355×250	R011916 xy	120	95	260
355×315	R011918 xy	120	95	260
400×160	R012012 xy	105	190	470
400×200	R012014 xy	110	190	470
400×250	R012016 xy	117	190	470
400×315	R012018 xy	126	190	470
450×315	R012118 xy	120	120	325
450×355	R012119 xy	120	120	325
450×400	R012120 xy	120	120	325
500×355	R012219 xy	120	120	325
500×400	R012220 xy	120	120	325
500×450	R012221 xy	101	101	400
560×400	R012320 xy	101	101	400
630×400	R012420 xy	101	101	400
630×500	R012422 xy	101	101	400
630×560	R012423 xy	101	101	400

• Producing up to size 315mm with SDR 9 and SDR7.4

length tolerance: ±(2-5 mm)

Producing other sizes that are not mentioned above is possible

• Consider x and y of product code as follow:

		PE100-Black				PE100-Natural			
x		B				C			
SDR		7.4	9	11	13.6	17	21	26	
y		2	3	4	5	6	7	8	

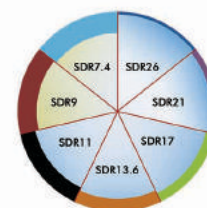

Concentric Reducer Short spigot

Литые Одноступенчатые Переходники

ISO 4427 | INSO 14427 | HDPE 100

Reduktion konzentrische,
kurze Schenkel

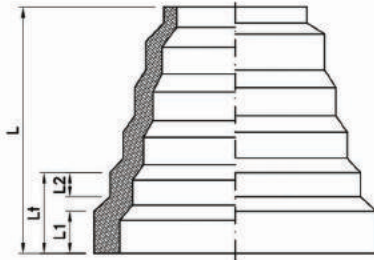

Nominal size (mm)	Sub Dimension	Code	L ₁ (mm)	L ₂ (mm)	L _t (mm)	L (mm)
140×75	90×75	R020807 xy	25	17	54	201
	110×90	R020908 xy	30	25	80	
	110×75	R020907 xy	30	17	116	
	125×75	R021007 xy	30	30	155	
	125×90	R021008 xy	30	25	135	
	125×110	R021009 xy	30	30	72	
	140×75	R021107 xy	31	17	201	
	140×90	R021108 xy	31	25	172	
	140×110	R021109 xy	31	30	120	
	140×125	R021110 xy	31	30	75	
200×110	125×110	R021009 xy	25	25	56	220
	160×110	R021209 xy	35	25	121	
	160×125	R021210 xy	35	25	70	
	180×110	R021309 xy	31	25	165	
	180×125	R021310 xy	31	25	100	
	180×160	R021312 xy	31	35	78	
	200×110	R021409 xy	36	25	220	
	200×125	R021410 xy	36	25	111	
	200×160	R021412 xy	36	35	145	
	200×180	R021413 xy	36	31	94	

length tolerance: ±(2-5 mm)

• Consider x and y of product code as follow:

PE100-Black				PE100-Natural			
x	B			C			
SDR	7.4	9	11	13.6	17	21	26
y	2	3	4	5	6	7	8

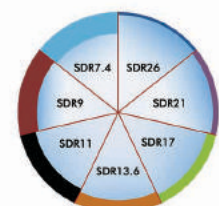

Concentric Reducer Short spigot

Литые Одноступенчатые Переходники

ISO 4427 | INSO 14427 | HDPE 100

Reduktion konzentrische,
kurze Schenkel

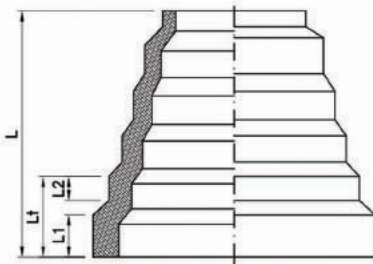

Nominal size (mm)	Sub Dimension	Code	L ₁ (mm)	L ₂ (mm)	L _t (mm)	L (mm)
315×160	200×160	R021412 xy	29	30	80	265
	225×160	R021512 xy	29	30	121	
	225×200	R021514 xy	28	29	70	
	250×160	R021612 xy	30	30	158	
	250×200	R021614 xy	30	29	108	
	250×225	R021615 xy	30	28	70	
	280×160	R021712 xy	28	30	201	
	280×200	R021714 xy	28	29	146	
	280×225	R021715 xy	28	28	109	
	280×250	R021716 xy	28	30	68	
	315×160	R021812 xy	47	30	265	
	315×200	R021814 xy	47	29	212	
	315×225	R021815 xy	47	28	172	
	315×250	R021816 xy	47	30	131	
400×200	315×280	R021817 xy	47	28	91	395
	225×200	R021514 xy	41	31	64	
	250×200	R021614 xy	40	31	148	
	250×225	R021615 xy	40	41	98	
	315×200	R021814 xy	39	31	240	
	315×225	R021815 xy	39	41	188	
	315×250	R021816 xy	39	40	129	
	355×200	R021914 xy	39	31	307	
	355×225	R021915 xy	39	41	257	
	355×250	R021916 xy	39	40	198	
	355×315	R022019 xy	39	39	109	
	400×200	R022114 xy	63	31	395	
	400×225	R022115 xy	63	41	350	
	400×250	R022116 xy	63	40	290	
400×315	R022118 xy	63	39	200		
400×355	R022119 xy	63	39	132		

length tolerance: ±(2-5 mm)

• Consider x and y of product code as follow:

PE100-Black				PE100-Natural			
x	B			C			
SDR	7.4	9	11	13.6	17	21	26
y	2	3	4	5	6	7	8

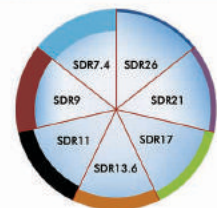

Eccentric Reducer

Длинные эксцентриские переходники

Reduktion exzentrisch

ISO 4427 | INSO 14427 | HDPE 100

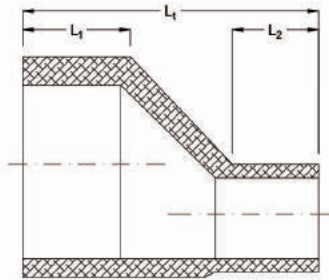

Nominal size (mm)	Code	L ₁ (mm)	L ₂ (mm)	L _t (mm)
90×50	R110805 xy	50	35	150
90×63	R110806 xy	50	35	150
90×75	R110807 xy	50	35	150
110×50	R110905 xy	50	35	150
110×63	R110906 xy	50	35	150
110×75	R110907 xy	50	35	150
110×90	R110908 xy	50	35	150
125×63	R111006 xy	50	35	150
125×75	R111007 xy	50	35	150
125×90	R111008 xy	50	35	150
125×110	R111009 xy	50	35	150
160×90	R111208 xy	50	35	180
160×110	R111209 xy	50	35	180
160×125	R111210 xy	50	35	180
160×140	R111211 xy	50	35	180
180×90	R111308 xy	50	35	180
180×110	R111309 xy	50	35	180
180×125	R111310 xy	50	35	180
180×140	R111311 xy	50	35	180
180×160	R111312 xy	50	35	180
200×110	R111409 xy	50	40	185
200×125	R111410 xy	50	40	185
200×140	R111411 xy	50	40	185
200×160	R111412 xy	50	40	185
200×180	R111413 xy	50	40	185

length tolerance: ±5 mm

- Producing up to size 315mm with SDR 9 and SDR7.4
- Producing other length in accordance to customer drawing is possible
- Consider x and y of product code as follow:

		PE100-Black				PE100-Natural			
x		B				C			
SDR		7.4	9	11	13.6	17	21	26	
y		2	3	4	5	6	7	8	

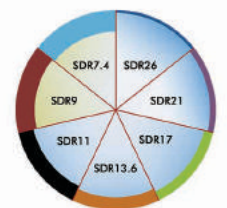

Eccentric Reducer

Длинные эксцентрисческие переходники

Reduktion exzentrisch

ISO 4427 | INSO 14427 | HDPE 100

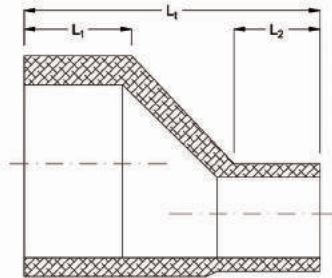

Nominal size (mm)	Code	L ₁ (mm)	L ₂ (mm)	L _t (mm)
225×110	R111509 xy	50	40	185
225×125	R111510 xy	50	40	185
225×140	R111511 xy	50	40	185
225×160	R111512 xy	50	40	185
225×180	R111513 xy	50	40	185
225×200	R111514 xy	50	40	185
250×140	R111611 xy	50	40	185
250×160	R111612 xy	50	40	205
250×180	R111613 xy	50	40	205
250×200	R111614 xy	50	40	205
250×225	R111615 xy	50	40	205
315×200	R111814 xy	50	40	220
315×225	R111815 xy	50	40	220
315×250	R111816 xy	50	40	220
355×200	R111914 xy	50	40	220
355×225	R111915 xy	50	40	220
355×250	R111916 xy	50	40	220
355×315	R111918 xy	50	40	220
400×200	R112014 xy	50	40	220
400×225	R112015 xy	50	40	220
400×250	R112016 xy	50	40	220
400×315	R112018 xy	50	40	220
400×355	R112019 xy	50	40	220

length tolerance: ±5 mm

- Producing up to size 315mm with SDR 9 and SDR7.4
- Producing other length in accordance to customer drawing is possible
- Consider x and y of product code as follow:

	PE100-Black				PE100-Natural			
x	B				C			
SDR	7.4	9	11	13.6	17	21	26	
y	2	3	4	5	6	7	8	

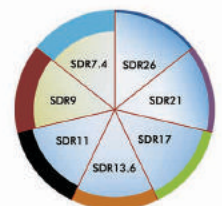

End Cap

Длтые Заглушки

Endkappe

ISO 4427 | INSO 14427 | HDPE 100

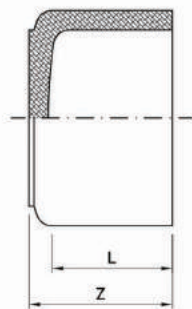

Nominal size (mm)	Code	Z (mm)	L (mm)
32	CA10303 xy	50	40
40	CA10404 xy	62	57
50	CA10505 xy	63	57
63	CA10606 xy	64	52
75	CA10707 xy	65	57
90	CA10808 xy	78	65
110	CA10909 xy	88	68
125	CA11010 xy	91	79
160	CA11212 xy	100	88
200	CA11414 xy	166	114
225	CA11515 xy	166	114
250	CA11616 xy	135	120
280	CA11717 xy	195	170
315	CA11818 xy	250	150
355	CA11919 xy	250	150
400	CA12020 xy	250	150
450	CA12121 xy	260	100
500	CA12222 xy	480	100
560	CA12323 xy	680	100
630	CA12424 xy	720	115

• Producing up to size 315mm with SDR 9 and SDR7.4
length tolerance: $\pm(2-5 \text{ mm})$

• Consider x and y of product code as follow:

		PE100-Black				PE100-Natural			
x		B				C			
SDR		7.4	9	11	13.6	17	21	26	
y		2	3	4	5	6	7	8	

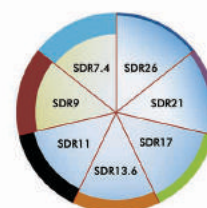

Cross Длтые Крестовины

Kreuzstück

ISO 4427 | INSO 14427 | HDPE 100

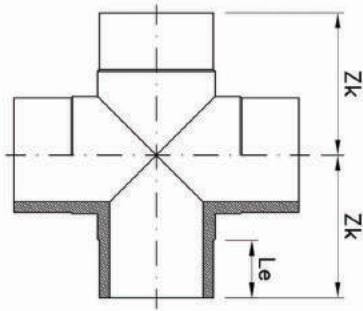

Nominal size (mm)	Code	Z_k (mm)	L_e (mm)
*63	CR10606 xy	106	60
*75	CR10707 xy	124	72
90	CR10808 xy	136	70
110	CR10909 xy	165	85
160	CR11212 xy	206	101
200	CR11414 xy	246	118
250	CR11616 xy	303	144
*315	CR11818 xy	299	125
*355	CR11919 xy	325	125
*400	CR12020 xy	325	125

* injection and welding
length tolerance: $\pm(2-5 \text{ mm})$

• Consider x and y of product code as follow:

	PE100-Black				PE100-Natural			
x	B				C			
SDR	7.4	9	11	13.6	17	21	26	
y	2	3	4	5	6	7	8	

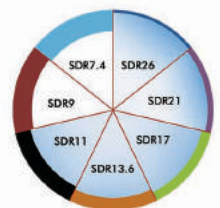

TAKAB ETTESAL
Plastic pipe and fittings Manufacturer Co.

Fabricated Fittings



Fabricated Elbow 90°

Сварные Отвод 90°

Segmentenschweißwinkel 90°

ISO 4427 | INSO 14427 | HDPE 100

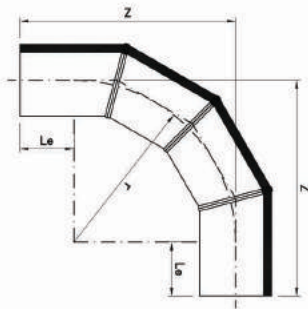

Nominal Size (mm)	Code	Z _{min} (mm)	*r (mm)	L _e (mm)
90	E040808 xy	261	135	150
110	E040909 xy	315	165	
125	E041010 xy	338	188	
140	E041111 xy	360	210	
160	E041212 xy	390	240	
180	E041313 xy	420	270	
200	E041414 xy	450	300	
225	E041515 xy	488	338	
250	E041616 xy	625	375	250
280	E041717 xy	670	420	
315	E041818 xy	773	473	300
355	E041919 xy	833	533	
400	E042020 xy	900	600	
450	E042121 xy	975	675	
500	E042222 xy	1100	750	350
560	E042323 xy	1190	840	
630	E042424 xy	1295	945	
710	E042525 xy	1415	1065	
800	E042626 xy	1550	1200	400
900	E042727 xy	1750	1350	
1000	E042828 xy	1900	1500	

Segment fittings have a pressure reduction factor of 0.8

$\alpha = \pm 2^\circ$

*r = 1.5 d

r > 1.5 d: possible as agreement

• Consider x and y of product code as follow:

	PE100-Black				PE100-Natural			
x	B				C			
SDR	7.4	9	11	13.6	17	21	26	
y	2	3	4	5	6	7	8	

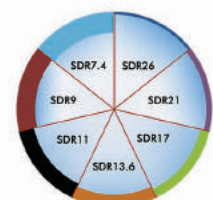

Fabricated Elbow 45°, 60°

Сварные Отвод 45°, 60°

Segmentenschweißwinkel 45°, 60°

ISO 4427 | INSO 14427 | HDPE 100

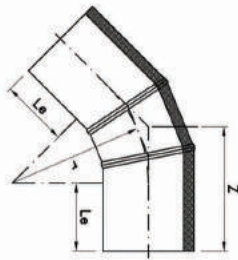

Nominal Size (mm)	Code		Z _{min} (mm)		*r (mm)	L _s (mm)
	45°	60°	45°	60°		
90	E030808 xy	E060808 xy	189	207	165	150
110	E030909 xy	E060909 xy	218	245	165	
125	E031010 xy	E061010 xy	228	258	188	
140	E031111 xy	E061111 xy	237	271	210	
160	E031212 xy	E061212 xy	249	288	240	
180	E031313 xy	E061313 xy	262	305	270	
200	E031414 xy	E061414 xy	274	323	300	
225	E031515 xy	E061515 xy	290	345	338	
250	E031616 xy	E061616 xy	412	466	375	250
280	E031717 xy	E061717 xy	424	492	420	
315	E031818 xy	E061818 xy	498	576	473	300
355	E031919 xy	E061919 xy	520	606	533	
400	E032020 xy	E062020 xy	548	646	600	
450	E032121 xy	E062121 xy	580	689	675	
500	E032222 xy	E062222 xy	665	783	750	350
560	E032323 xy	E062323 xy	698	835	840	
630	E032424 xy	E062424 xy	741	896	945	
710	E032525 xy	E062525 xy	792	965	1065	
800	E032626 xy	E062626 xy	847	1043	1200	400
900	E032727 xy	E062727 xy	960	1179	1350	
1000	E032828 xy	E062828 xy	1022	1266	1500	

Segment fittings have a pressure reduction factor of 0.8

$\alpha = \pm 2^\circ$

*r=1.5 d

r > 1.5 d: possible as agreement

• Consider x and y of product code as follow:

	PE100-Black				PE100-Natural			
x	B				C			
SDR	7.4	9	11	13.6	17	21	26	
y	2	3	4	5	6	7	8	

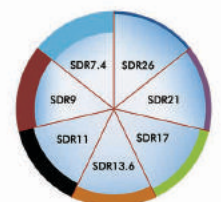

Fabricated Equal Tee 90°

Равные Сварные Тройники 90°

ISO 4427 | INSO 14427 | HDPE 100

Segmentgeschweißtes
T-Stück 90°

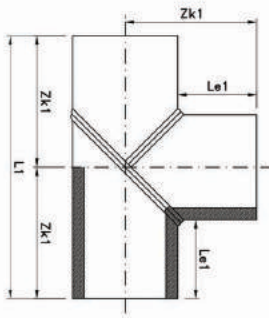

Nominal Size (mm)	Code	ZK1 _{min} (mm)	L ₁ (mm)	L ₀₁ (mm)
90	T020808 xy	170	360	150
110	T020909 xy	205	410	
125	T021010 xy	215	430	
140	T021111 xy	220	440	
160	T021212 xy	230	460	
180	T021313 xy	240	480	
200	T021414 xy	250	500	
225	T021515 xy	265	530	
250	T021616 xy	375	750	250
280	T021717 xy	390	780	
315	T021818 xy	460	920	300
355	T021919 xy	480	960	
400	T022020 xy	500	1000	
450	T022121 xy	525	1050	
500	T022222 xy	600	1200	350
560	T022323 xy	630	1260	
630	T022424 xy	665	1330	
710	T022525 xy	705	1410	
800	T022626 xy	750	1500	

Segment fittings have a pressure reduction factor of 0.5
 $\alpha = \pm 2^\circ$

• Consider x and y of product code as follow:

	PE100-Black			PE100-Natural			
x	B			C			
SDR	7.4	9	11	13.6	17	21	26
y	2	3	4	5	6	7	8

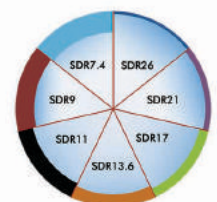

Saddle Fusion Tee 90°

Литые Тройники Переходные 90°

ASTM F2620 | INSO 14427 | HDPE 100

Saddle Fusion T-Stück
(nach ASTM F2620)

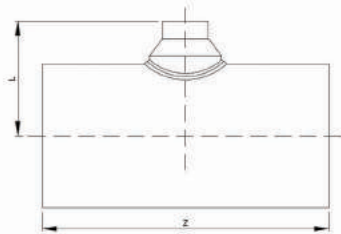

Nominal size (mm)	Code	Z (mm)	L _{min} (mm)	
315 × 125	T031810 xy	600	250	
315 × 110	T031809 xy			
315 × 90	T031808 xy			
315 × 75	T031807 xy			
315 × 63	T031806 xy			
355 × 160	T031912 xy	700	280	
355 × 125	T031910 xy	650		
355 × 110	T031909 xy			
355 × 90	T031908 xy			
355 × 75	T031907 xy			
355 × 63	T031906 xy	700	310	
400 × 160	T032012 xy			
400 × 125	T032010 xy			650
400 × 110	T032009 xy			
400 × 90	T032008 xy			
400 × 75	T032007 xy			
400 × 63	T032006 xy	750	350	
450 × 200	T032114 xy			
450 × 180	T032113 xy			650
450 × 160	T032112 xy			
450 × 125	T032110 xy			
450 × 110	T032109 xy			
450 × 90	T032108 xy	650		
450 × 75	T032107 xy			
450 × 63	T032106 xy			

• Consider x and y of product code as follow:

	PE100-Black			PE100-Natural		
x	B			C		
SDR	11	13.6	17	21	26	
y	4	5	6	7	8	

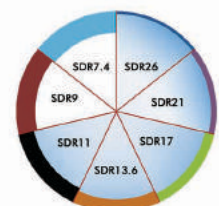

Saddle Fusion Tee 90°

Литые Тройники Переходные 90°

ASTM F2620 | INSO 14427 | HDPE 100

Saddle Fusion T-Stück
(nach ASTM F2620)

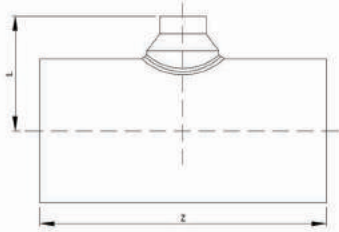

Nominal size (mm)	Code	Z (mm)	L _{min} (mm)	
500 × 200	T032214 xy	800	380	
500 × 180	T032213 xy			
500 × 160	T032212 xy			
500 × 125	T032210 xy			
500 × 110	T032209 xy			
500 × 90	T032208 xy	700		
500 × 75	T032207 xy			
500 × 63	T032206 xy			
560 × 225	T032315 xy			
560 × 200	T032314 xy			
560 × 180	T032313 xy	1000	410	
560 × 160	T032312 xy			
560 × 125	T032310 xy			
560 × 110	T032309 xy			
560 × 90	T032308 xy			
630 × 250	T032416 xy	1100		460
630 × 225	T032415 xy			
630 × 200	T032414 xy			
630 × 180	T032413 xy			
630 × 160	T032412 xy			
630 × 110	T032410 xy	1000		
630 × 90	T032409 xy			

• Consider x and y of product code as follow:

	PE100-Black			PE100-Natural		
x	B			C		
SDR	11	13.6	17	21	26	
y	4	5	6	7	8	

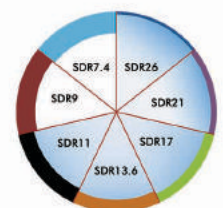

Saddle Fusion Tee 90°

Литые Тройники Переходные 90°

ASTM F2620 | INSO 14427 | HDPE 100

Saddle Fusion T-Stück
(nach ASTM F2620)

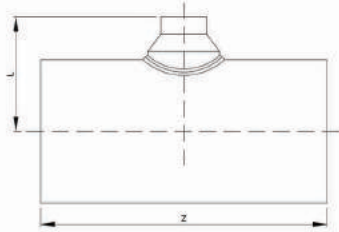

Nominal size (mm)	Code	Z (mm)	L _{min} (mm)
710 × 280	T032517 xy	1200	500
710 × 250	T032516 xy		
710 × 225	T032515 xy		
710 × 200	T032514 xy		
710 × 180	T032513 xy		
710 × 160	T032512 xy		
710 × 110	T032509 xy	1100	500
710 × 90	T032508 xy		
710 × 280	T032517 xy	1300	570
710 × 250	T032516 xy		
800 × 315	T032618 xy		
800 × 280	T032617 xy		
800 × 250	T032616 xy		
800 × 225	T032615 xy		
800 × 200	T032614 xy	1200	570
800 × 180	T032613 xy		
800 × 160	T032612 xy		
900 × 400	T032720 xy		
900 × 315	T032718 xy	1400	620
900 × 250	T032716 xy		
900 × 200	T032714 xy		
900 × 160	T032712 xy	1300	620

• Consider x and y of product code as follow:

	PE100-Black			PE100-Natural		
x	B			C		
SDR	11	13.6	17	21	26	
y	4	5	6	7	8	

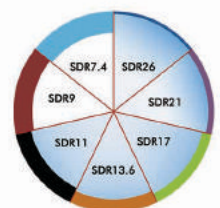

Fabricated Equal Tee 45°,60°

Равные Сварные Тройники 45°,60°

ISO 4427 | INSO 14427 | HDPE 100

Segmentgeschweißtes
T-Stück 45°, 60°

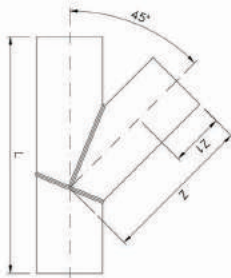

Nominal Size (mm)	Code		Z _{min} (mm)	L (mm)	Z ₁ (mm)
	45°	60°			
90	T270808 xy	T340808 xy	295	445	150
110	T270909 xy	T340909 xy	325	500	
125	T271010 xy	T341010 xy	355	545	
140	T271111 xy	T341111 xy	375	581	
160	T271212 xy	T341212 xy	412	642	
180	T271313 xy	T341313 xy	450	700	
200	T271414 xy	T341414 xy	487	759	
225	T271515 xy	T341515 xy	530	830	250
250	T271616 xy	T341616 xy	580	905	
280	T271717 xy	T341717 xy	630	995	300
315	T271818 xy	T341818 xy	690	1090	
355	T271919 xy	T341919 xy	730	1155	
400	T272020 xy	T342020 xy	800	1250	
450	T272121 xy	T342121 xy	850	1325	
500	T272222 xy	T342222 xy	900	1400	350
560	T272323 xy	T342323 xy	950	1480	
630	T272424 xy	T342424 xy	1000	1545	

Segment fittings have a pressure reduction factor of 0.5
 $\alpha = \pm 2^\circ$

• Consider x and y of product code as follow

	PE100-Black			PE100-Natural			
x	B			C			
SDR	7.4	9	11	13.6	17	21	26
y	2	3	4	5	6	7	8

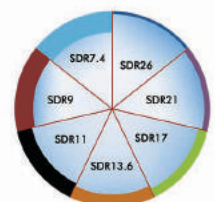

Fabricated Cross 90°

Равные Сварные Тройники 90°

ISO 4427 | INSO 14427 | HDPE 100

Segmentgeschweißtes
kreuzstück 90°

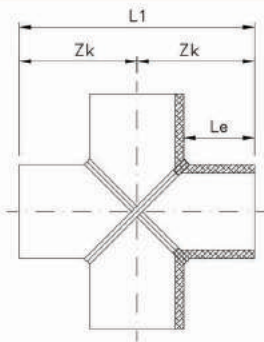

Nominal Size (mm)	Code	ZK _{min} (mm)	L ₁ (mm)	L _e (mm)
90	CR20808 xy	170	360	150
110	CR20909 xy	205	410	
125	CR21010 xy	215	430	
140	CR21111 xy	220	440	
160	CR21212 xy	230	460	
180	CR21313 xy	240	480	
200	CR21414 xy	250	500	
225	CR21515 xy	265	530	250
250	CR21616 xy	375	750	
280	CR21717 xy	390	780	300
315	CR21818 xy	460	920	
355	CR21919 xy	480	960	
400	CR22020 xy	500	1000	
450	CR22121 xy	525	1050	350
500	CR22222 xy	600	1200	
560	CR22323 xy	630	1260	
630	CR22424 xy	665	1330	

$\alpha = \pm 2^\circ$

- Consider x and y of product code as follow

	PE100-Black			PE100-Natural			
x	B			C			
SDR	7.4	9	11	13.6	17	21	26
y	2	3	4	5	6	7	8

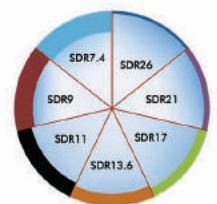

TAKAB ETTESAL
Plastic pipe and fittings Manufacturer Co.

Flanged Joint Fittings



Steel Core Hole Flange

Фланцы Со Стальными Сердечниками

Vorschweißbund
mit Stahleinlage

EN 1092-1 | INSO 14427 | HDPE 100

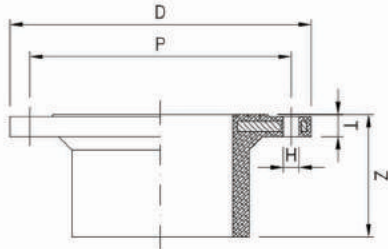

Nominal Size (mm)	Code	D(mm)		P(mm)		Z (mm)	T (mm)	H(mm)		Bolt Number	
		SDR 17	SDR 11	SDR 17	SDR 11			SDR 17	SDR 11	SDR 17	SDR 11
63	FL50606 xy	165		125		82	18	18		4	
75	FL50707 xy	185		145		100	18	18		8	
90	FL50808 xy	200		160		106	20	18		8	
110	FL50909 xy	220		180		112	20	18		8	
125	FL51010 xy	250		210		124	22	18		8	
160	FL51212 xy	285		240		132	25	22		8	
200	FL51414 xy	340		295		140	25	22		8	12*
250	FL51616 xy	395	405	350	355	160	25	22	26	12	
315	FL51818 xy	445	460	400	410	180	35	22	26	12	
355	FL51919 xy	505	520	460	470	195	35	26	26	16	
400	FL52020 xy	565	580	515	525	205	40	30	30	16	

*Future Product

Flange boring according to EN1092-1

Buttwelding part according to INSO14427

• Consider x and y of product code as follow:

	PE100-Black				PE100-Natural			
x	B				C			
SDR	11	17	21	26				
y	4	6	7	8				

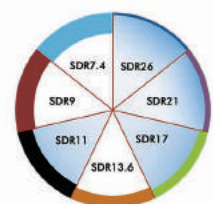

Steel Core Hole Flanged Equal Tee 90°

Фланцы Со Стальными Сердечниками Тройники 90°

Geflanschtes T-Stück 90° mit
Stahleinlage

EN 1092-1 | INSO 14427 | HDPE 100

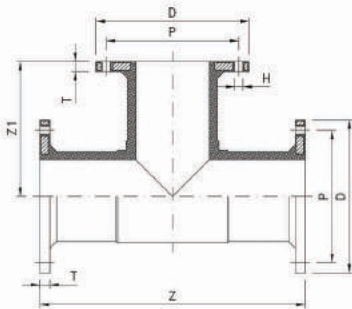

Nominal size (mm)	Code	D (mm)		P (mm)		Z ₁ (mm) (min)	Z (mm) (min)	T (mm) ±2	H (mm)		Bolt Number	
		SDR 17	SDR 11	SDR 17	SDR 11				SDR 17	SDR 11	SDR 17	SDR 11
63	T140606 xy	165		125		160	320	18	18		4	
75	T140707 xy	185		145		165	330	18	18		8	
90	T140808 xy	200		160		165	330	20	18		8	
110	T140909 xy	220		180		180	360	20	18		8	
125	T141010 xy	250		180		200	400	22	18		8	
160	T141212 xy	285		240		220	440	25	22		8	
200	T141414 xy	340		295		260	520	25	22		8	12*
250	T141616 xy	395	405	350	355	350	700	25	22	26	12	
315	T141818 xy	445	460	400	410	400	800	35	22	26	12	
355	T141919 xy	505	520	460	470	425	850	35	22	26	16	
400	T142020 xy	565	580	515	525	450	900	40	26	30	16	

*Future Product

Flange boring according to EN1092-1

- Consider x and y of product code as follow:

		PE100-Black				PE100-Natural			
x		B				C			
SDR		11	17	21	26				
y		4	6	7	8				

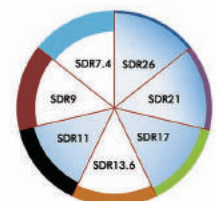

Steel Core Hole Flanged Reduced Tee 90°

Фланцы Со Стальными Сердечниками Не Равные Тройники 90°

Geflanshtes T-Stück 90°
reduziert mit Stahleinlage

EN 1092-1 | INSO 14427 | HDPE 100

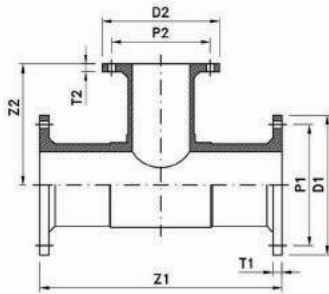

Nominal size (mm)	Code	D ₁ (mm)		D ₂ (mm)		P ₁ (mm)		P ₂ (mm)		Z ₁ (mm) (min)	Z ₂ (mm) (min)	T ₁ (mm) ± 2	T ₂ (mm) ± 2
		SDR 17	SDR 11	SDR 17	SDR 11	SDR 17	SDR 11	SDR 17	SDR 11				
75×63	T140706 xy	185		165		145		125		330	165	18	18
90×63	T140806 xy	200		165		160		125		330	165	20	18
90×75	T140807 xy	200		185		160		145		330	165	20	18
110×63	T140906 xy	220		165		180		125		320	165	20	18
110×75	T140907 xy	220		185		180		145		360	175	20	18
110×90	T140908 xy	220		200		180		160		360	175	20	20
125×63	T141006 xy	250		165		180		125		400	180	22	18
125×75	T141007 xy	250		185		180		145		400	190	22	18
125×90	T141008 xy	250		200		180		160		400	190	22	20
125×110	T141009 xy	250		220		180		180		400	195	22	20
160×63	T141206 xy	285		165		240		125		440	190	25	18
160×75	T141207 xy	285		185		240		145		440	205	25	18
160×90	T141208 xy	285		200		240		160		440	205	25	20
160×110	T141209 xy	285		220		240		180		440	210	25	20
160×125	T141210 xy	285		250		240		180		440	215	25	22
200×75	T141407 xy	340		185		295		145		520	215	25	18
200×90	T141408 xy	340		200		295		160		520	235	25	20
200×110	T141409 xy	340		220		295		180		520	240	25	20
200×125	T141410 xy	340		250		295		180		520	240	25	22
200×160	T141412 xy	340		285		295		240		520	250	25	25
250×90	T141608 xy	395	405	200		350	355	160		700	265	25	20
250×110	T141609 xy	395	405	220		350	355	180		700	270	25	20
250×160	T141612 xy	395	405	285		350	355	240		700	280	25	25
315×90	T141808 xy	445	460	200		400	410	160		800	295	35	20
315×110	T141809 xy	445	460	220		400	410	180		800	300	35	20

Flange boring according to EN1092-1

• Consider x and y of product code as follow:

PE100-Black					PE100-Natural				
x	B				C				
SDR	11	17	21	26					
y	4	6	7	8					

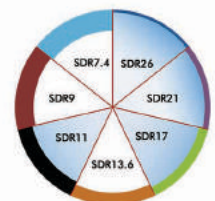

Steel Core Hole Flanged Reduced Tee 90°

Фланцы Со Стальными Сердечниками Не Равные Тройники 90°

Geflanschtes T-Stück 90°
reduziert mit Stahleinlage

EN 1092-1 | INSO 14427 | HDPE 100

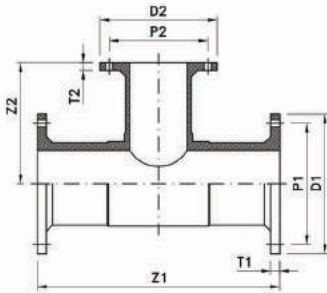

Nominal size (mm)	Code	D ₁ (mm)		D ₂ (mm)		P ₁ (mm)		P ₂ (mm)		Z ₁ (mm) (min)	Z ₂ (mm) (min)	T ₁ (mm) ± 2	T ₂ (mm) ± 2
		SDR 17	SDR 11	SDR 17	SDR 11	SDR 17	SDR 11	SDR 17	SDR 11				
315×160	T141812 xy	445	460	285		400	410	240		800	310	35	25
315×200	T141814 xy	445	460	340		400	410	295		800	320	35	25
315×250	T141816 xy	445	460	395	405	400	410	350	355	800	330	35	25
355×90	T141908 xy	505	520	200		460	470	160		850	330	35	20
355×110	T141909 xy	505	520	220		460	470	180		850	330	35	20
355×160	T141912 xy	505	520	285		460	470	240		850	340	35	25
355×200	T141914 xy	505	520	340		460	470	295		850	350	35	25
355×250	T141916 xy	505	520	395	405	460	470	350	355	850	360	35	25
355×315	T141918 xy	505	520	445	460	460	470	400	410	850	380	35	35
400×160	T142012 xy	565	580	285		515	525	240		900	370	40	25
400×200	T142014 xy	565	580	340		515	525	295		900	380	40	25
400×250	T142016 xy	565	580	395	405	515	525	350	355	900	390	40	25
400×315	T142018 xy	565	580	445	460	515	525	400	410	900	400	40	35
400×355	T142019 xy	565	580	505	520	515	525	460	470	900	410	40	35

Flange boring according to EN1092-1

- Consider x and y of product code as follow:

		PE100-Black				PE100-Natural	
x		B				C	
SDR	y	11	17	21	26		
	4		6	7	8		

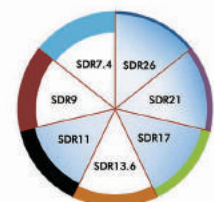

Steel Core Hole Flanged Reducer

Фланцы Со Стальными Сердечниками редуктор

Geflanschtes reduction mit
Stahleinlage

EN 1092-1 | INSO 14427 | HDPE 100

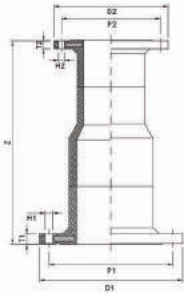

Nominal size (mm)	Code	L ₁ (mm) min	D ₁ (mm)		D ₂ (mm)		P ₁ (mm)		P ₂ (mm)		T ₁ (mm) ±2	T ₂ (mm) ±2
			SDR 17	SDR 11	SDR 17	SDR 11	SDR 17	SDR 11	SDR 17	SDR 11		
			200×160	R091412 xy	300	340		285		295		
250 ×90	R091608 xy	300	395	405	200		350	355	160		25	20
250×110	R091609 xy	300	395	405	220		350	355	180		25	20
250×160	R091612 xy	300	395	405	285		350	355	240		25	25
250×200	R091614 xy	300	395	405	340		350	355	295		25	25
315×160	R091812 xy	300	445	460	285		400	410	240		35	25
315×200	R091814 xy	300	445	460	340		400	410	295		35	25
315×250	R091816 xy	300	445	460	395	405	400	410	350	355	35	25
355×160	R091912 xy	300	505	520	285		460	470	240		35	25
355×200	R091914 xy	300	505	520	340		460	470	295		35	25
355×250	R091916 xy	300	505	520	395	405	460	470	350	355	35	25
355×315	R091918 xy	300	505	520	445	460	460	470	400	410	35	35
400×160	R092012 xy	300	565	580	285		515	525	240		40	25
400×200	R092014 xy	300	565	580	340		515	525	295		40	25
400×250	R092016 xy	300	565	580	395	405	515	525	350	355	40	25
400×315	R092018 xy	300	565	580	445	460	515	525	400	410	40	35
400×355	R092019 xy	300	565	580	505	520	515	525	460	470	40	35

Flange boring according to EN1092-1

• Consider x and y of product code as follow:

		PE100-Black				PE100-Natural			
x		B				C			
SDR		11	17	21	26				
y		4	6	7	8				

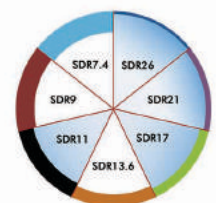

PP-Steel Backing Ring (PN10)

PP-Металлические Кольца

Flansch aus PP mit Stahleinlage
(nach EN1092-PN10)

EN1092-1

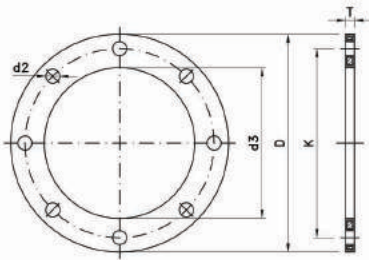

Flange Size (mm)	Code	D (mm)	d ₃ (mm)	K (mm)	d ₂ (mm)	Bolt Number	T (mm)
63	RL10620P6	165	78	125	18	4	18
75	RL10720P6	185	92	145	18	8	18
90	RL10820P6	200	108	160	18	8	20
110	RL10922P6	220	128	180	18	8	20
125	RL11022P6	220	135	180	18	8	22
160	RL11224P6	285	178	240	22	8	25
180	RL11324P6	285	188	240	22	8	25
200	RL11424P6	340	235	295	22	8	28
225	RL11524P6	340	238	295	22	8	28
250	RL11626P6	395	288	350	22	12	30
315	RL11826P6	445	338	400	22	12	35
355	RL11930P6	505	376	460	26	16	35
400	RL12032P6	565	430	515	30	16	40

Steel Backing Ring (PN10)

Металлические Кольца

Losflansch(nach EN1092-PN10)

EN1092-1

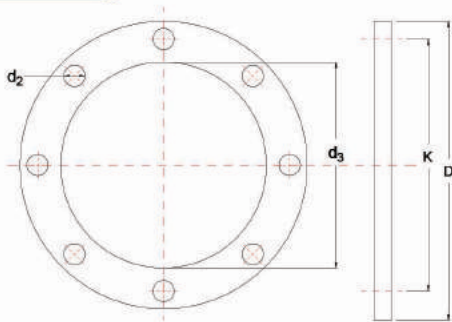

DN	Pipe Outside (mm)	Code	D (mm)	d ₃ (mm)	K (mm)	d ₂ (mm)	Bolting	
							Number	Size
20	25	RL40116 x6	105	34	75	14	4	M12
25	32	RL40216 x6	115	42	85	14	4	M12
32	40	RL40318 x6	140	51	100	18	4	M16
40	50	RL40418 x6	150	62	110	18	4	M16
50	63	RL40620 x6	165	78	125	18	4	M16
65	75	RL40720 x6	185	92	145	18	8	M16
80	90	RL40820 x6	200	108	160	18	8	M16
100	110	RL40922 x6	220	128	180	18	8	M16
100	125	RL41022 x6	220	135	180	18	8	M16
125	140	RL41122 x6	250	158	210	18	8	M16
150	160	RL41224 x6	285	178	240	22	8	M20
150	180	RL41324 x6	285	188	240	22	8	M20
200	200	RL41424 x6	340	235	295	22	8	M20
200	225	RL41524 x6	340	238	295	22	8	M20
250	250	RL41626 x6	395	288	350	22	12	M20
250	280	RL41726 x6	395	294	350	22	12	M20
300	315	RL41826 x6	445	338	400	22	12	M20
350	355	RL41930 x6	505	376	460	22	16	M20
400	400	RL42032 x6	565	430	515	26	16	M24
450	450	RL42136 x6	615	517	565	26	20	M24
500	500	RL42238 x6	670	533	620	26	20	M24
600	560	RL42342 x6	780	618	725	30	20	M27
700	630	RL42450 x6	895	645	840	30	24	M27

• Consider x of product code as follow:

	Hot Galvanized	Cold Galvanized
x	w	s

Steel Backing Ring (PN16)

Металлические Кольца

Losflansch(nach EN1092-PN16)

EN1092-1

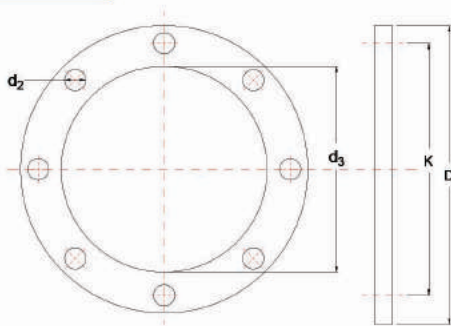

DN	Pipe Outside (mm)	Code	D (mm)	d ₃ (mm)	K (mm)	d ₂ (mm)	Bolting	
							Number	Size
20	25	RL40116 x4	105	34	75	14	4	M12
25	32	RL40216 x4	115	42	85	14	4	M12
32	40	RL40318 x4	140	51	100	18	4	M16
40	50	RL40418 x4	150	62	110	18	4	M16
50	63	RL40620 x4	165	78	125	18	4	M16
65	75	RL40720 x4	185	92	145	18	8	M16
80	90	RL40820 x4	200	108	160	18	8	M16
100	110	RL40922 x4	220	128	180	18	8	M16
100	125	RL41022 x4	220	135	180	18	8	M16
125	140	RL41122 x4	250	158	210	18	8	M16
150	160	RL41224 x4	285	178	240	22	8	M20
150	180	RL41324 x4	285	188	240	22	8	M20
200	200	RL41426 x4	340	235	295	22	12	M20
200	225	RL41526 x4	340	238	295	22	12	M20
250	250	RL41629 x4	405	288	355	26	12	M24
250	280	RL41729 x4	405	294	355	26	12	M24
300	315	RL41832 x4	460	338	410	26	12	M24
350	355	RL41935 x4	520	376	470	26	16	M24
400	400	RL42038 x4	580	430	525	30	16	M27
450	450	RL42142 x4	640	517	585	30	20	M27
500	500	RL42246 x4	715	533	650	33	20	M30
600	560	RL42355 x4	840	618	770	36	20	M33
700	630	RL42463 x4	910	645	840	36	24	M33

• Consider x of product code as follow:

	Hot Galvanized	Cold Galvanized
x	w	s

Steel Backing Ring (Class 150)

Металлические Кольца

Losflansch (Klasse 150)

ASME B16.5

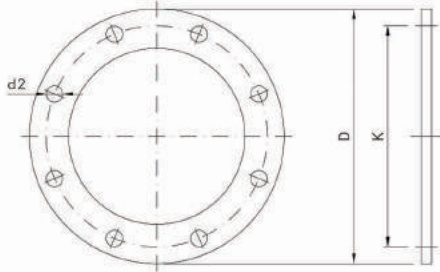

Pipe Outside		Code	D (mm)	K (mm)	d ₂ (mm)	Bolt Number
in	mm					
1/2	20	RL20111 x6	90	60.3	15.87	4
3/4	25	RL20212 x6	100	69.9	15.87	4
1	32	RL20314 x6	110	79.4	15.87	4
1 1/4	40	RL20416 x6	115	88.9	15.87	4
1 1/2	50	RL20518 x6	125	98.4	15.87	4
2	63	RL20622 x6	150	120.7	19.05	4
2 1/2	75	RL20724 x6	180	139.7	19.05	4
3	90	RL20824 x6	190	152.4	19.05	4
4	110	RL20924 x6	230	190.5	19.05	8
5	125	RL21024 x6	255	215.9	22.22	8
6	160	RL21225 x6	280	241.3	22.22	8
8	200	RL21228 x6	345	298.5	22.22	8
10	250	RL21630 x6	405	362.0	25.4	12
12	315	RL21832 x6	485	431.8	25.4	12
14	355	RL21935 x6	535	476.3	28.57	12
16	400	RL22036 x6	595	539.8	28.57	16
18	450	RL22140 x6	635	577.9	31.75	16
20	500	RL22242 x6	700	635.0	31.75	20
24	630	RL22450 x6	815	749.3	34.92	20

• Consider x of product code as follow:

	Hot Galvanized	Cold Galvanized
x	w	s

Steel Core Blind Flange

Стальной Глухой Фланец

Blindflansch aus PP mit
Stahleinlage (nach EN1092)

EN1092 | HDPE 100

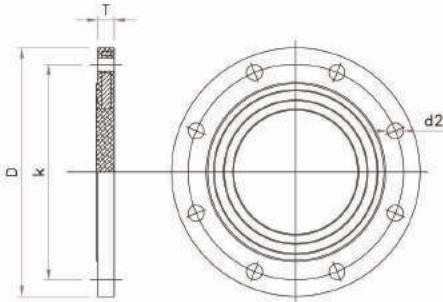

Nominal size (mm)	Code	D (mm)		k (mm)		T (mm) ±2	d ₂ (mm)		Bolt Number	
		PN10	PN16	PN10	PN16		PN10	PN16	PN10	PN16
63	FL60606 xy	165		125		18	18		4	
75	FL60707 xy	185		145		18	18		8	
90	FL60808 xy	200		160		20	18		8	
110	FL60909 xy	220		180		20	18		8	
125	FL61010 xy	250		180		22	18		8	
160	FL61212 xy	285		240		25	22		8	
200	FL61414 xy	340		295		25	22		8	12
250	FL61616 xy	395	405	350	355	25	22	26	12	
315	FL61818 xy	445	460	400	410	35	22	26	12	
355	FL61919 xy	505	520	460	470	35	22	26	16	
400	FL62020 xy	565	580	515	525	40	26	30	16	

• Consider x and y of product code as follow:

PE100-Black		PE100-Natural	
x	B	C	
SDR	11	17	26
y	4	6	8

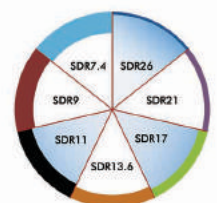

TAKAB ETTESAL
Plastic pipe and fittings Manufacturer Co.

Polypropylene Fittings

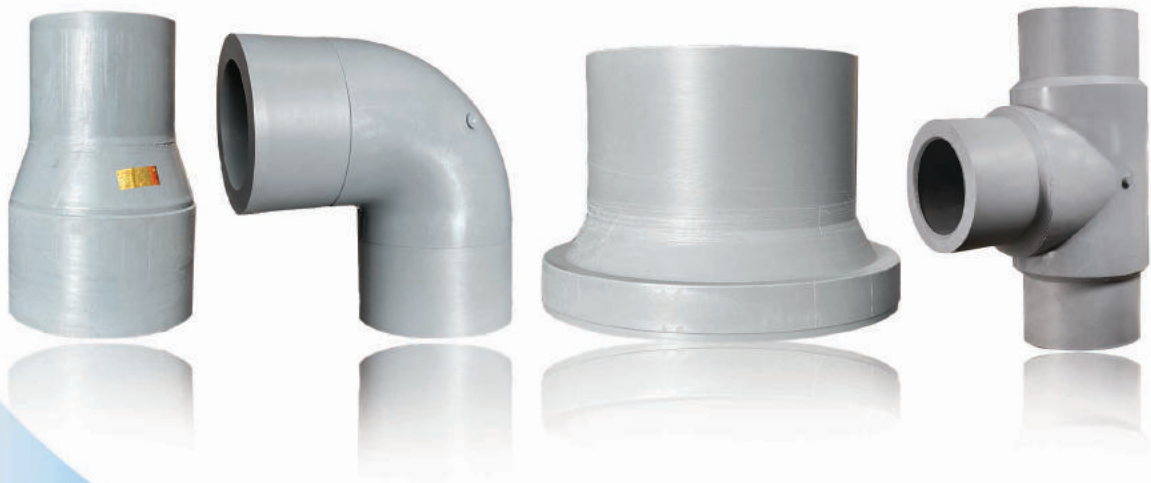



Polypropylene Pipe Specification DIN 8077, ISO 15494

Pipe series S and standard dimension ratio. SDR

Nominal outside diameter	S 20 SDR 41		S 16 SDR 33		S 12.5 SDR 26		S 8.3 SDR 17.6		S 8 SDR 17		S 5 SDR 11		S 4 SDR 9		S 3.2 SDR 7.4		S 2.5 SDR 6		S 2 SDR 5	
	e _n ^a mm	Mass ^b Kg/m	e _n ^a mm	Mass ^b Kg/m	e _n ^a mm	Mass ^b Kg/m	e _n ^a mm	Mass ^b Kg/m	e _n ^a mm	Mass ^b Kg/m	e _n ^a mm	Mass ^b Kg/m	e _n ^a mm	Mass ^b Kg/m	e _n ^a mm	Mass ^b Kg/m	e _n ^a mm	Mass ^b Kg/m	e _n ^a mm	Mass ^b Kg/m
110	2.7	0.903	3.4	1.12	4.2	1.37	6.3	1.99	6.6	2.09	10.0	3.01	12.3	3.62	15.1	4.30	18.3	5.01	22.1	5.78
125	3.1	1.18	3.9	1.45	4.8	1.76	7.1	2.55	7.4	2.65	11.4	3.91	14.0	4.66	17.1	5.53	20.8	6.47	25.1	7.46
140	3.5	1.48	4.3	1.8	5.4	2.23	8.0	3.20	8.3	3.32	12.7	4.87	15.7	5.86	19.2	6.95	23.3	8.12	28.1	9.35
160	4.0	1.91	4.9	2.32	6.2	2.92	9.1	4.17	9.5	4.33	14.6	6.38	17.9	7.62	21.9	9.04	26.6	10.6	32.1	12.2
180	4.4	2.38	5.5	2.94	6.9	3.63	10.2	5.25	10.7	5.47	16.4	8.07	20.1	9.64	24.6	11.4	29.0	13.4	36.1	15.4
200	4.9	2.92	6.2	3.68	7.7	4.50	11.4	6.50	11.9	6.75	18.2	9.95	22.4	11.9	27.4	14.1	33.2	16.5	-	-
225	5.5	3.70	6.9	4.57	8.6	5.65	12.8	8.19	13.4	8.56	20.5	12.6	25.2	15.1	30.8	17.9	37.4	20.9	-	-
250	6.2	4.63	7.7	5.67	9.6	6.99	14.2	10.1	14.8	10.5	22.7	15.5	27.9	18.5	34.2	22.1	-	-	-	-
280	6.9	5.73	8.6	7.09	10.7	8.72	15.9	12.6	16.6	13.2	25.4	19.4	31.3	23.3	38.3	27.6	-	-	-	-
315	7.7	7.20	9.7	8.97	12.1	11.1	17.9	16.0	18.7	16.7	28.6	24.6	35.2	29.5	-	-	-	-	-	-
355	8.7	9.14	10.9	11.3	13.6	14.0	20.1	20.3	21.1	21.2	32.2	31.2	39.7	37.4	-	-	-	-	-	-
400	9.8	11.6	12.3	14.4	15.3	17.8	22.7	25.7	23.7	26.8	36.3	39.6	-	-	-	-	-	-	-	-
450	11.0	14.7	13.8	18.2	17.2	22.5	25.5	32.5	26.7	33.9	40.9	50.1	-	-	-	-	-	-	-	-
500	12.3	18.2	15.3	22.6	19.1	27.7	28.4	40.2	29.7	41.9	-	-	-	-	-	-	-	-	-	-
560	13.7	22.6	17.2	28.2	21.4	34.7	31.7	50.3	33.2	52.5	-	-	-	-	-	-	-	-	-	-
630	15.4	28.6	19.3	35.6	24.1	44.0	35.7	63.7	37.4	66.5	-	-	-	-	-	-	-	-	-	-
710	17.4	36.4	21.8	45.2	27.2	55.9	40.2	80.8	42.1	84.4	-	-	-	-	-	-	-	-	-	-
800	19.6	46.1	24.5	57.2	30.6	70.8	45.3	103	47.4	107	-	-	-	-	-	-	-	-	-	-
900	22.0	58.3	27.6	72.5	34.4	89.5	51.0	130	53.3	135	-	-	-	-	-	-	-	-	-	-
1 000	24.5	72.0	30.6	89.2	38.2	110	-	-	-	-	-	-	-	-	-	-	-	-	-	-
1 200	29.4	104	36.7	128	45.9	159	-	-	-	-	-	-	-	-	-	-	-	-	-	-
1 400	34.3	141	42.9	175	53.5	216	-	-	-	-	-	-	-	-	-	-	-	-	-	-
1 600	39.2	184	49.0	228	61.2	283	-	-	-	-	-	-	-	-	-	-	-	-	-	-

^a The minimum wall thickness has been set as e=1.8 mm.

^b The masses have been calculated taking an average density of 0.910 g/cm³. For other densities, the masses shall be corrected proportionally. Half the specified tolerance has been added to the wall thickness. The values have been rounded to 3 decimal places.

PP-Flange Adaptor(Type A)

PP-Литые Фланцы

PP- Vorschweißbund (Typ A)

ISO 15494 | INSO 21266 | PP-R,PP-RCT

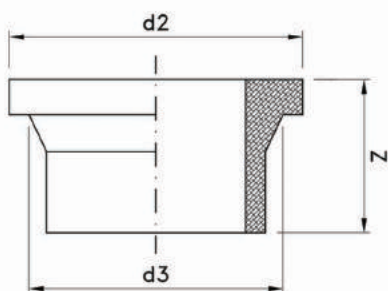

Nominal size (mm)	Code		d ² (mm)	d ³ (mm)	Z (mm)	
	Normal	Long			Normal	Long
63	FL10606P y	FL20606P y	102	75	92	95
75	FL10707P y	FL20707P y	122	89	110	120
90	FL10808P y	FL20808P y	138	105	125	140
110	FL10909P y	FL20909P y	158	125	120	160
125	FL11010P y	FL21010P y	158	132	120	170
140	FL11111P y	FL21111P y	188	155	152	200
160	FL11212P y	FL21212P y	212	175	155	200
180	FL11313P y	FL21313P y	212	180	171	199
200	FL11414P y	FL21414P y	268	232	193	199
225	FL11515P y	FL21515P y	268	235	200	200
250	FL11616P y	FL21616P y	320	285	204	204
280	FL11717P y	FL21717P y	320	291	171	210
315	FL11818P y	FL21818P y	370	335	173	210

• Consider y of product code as follow:

SDR	7.4	9	11	13.6	17
y	2	3	4	5	6

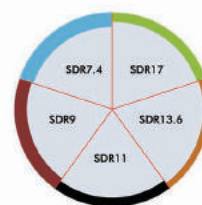

PP-Flange Adaptor(Type B)

PP-Литые Фланцы

PP- Vorschweißbund (Typ B)

ISO 15494 | INSO 21266 | PP-R,PP-RCT

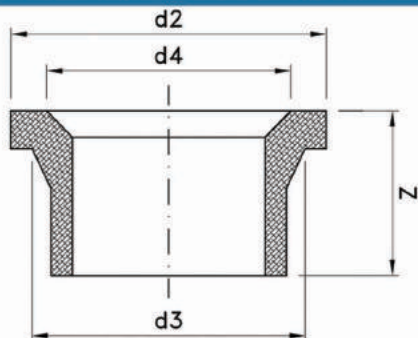

Nominal size (mm)	Code		d ₂ (mm)	d ₃ (mm)	d ₄ (mm)	Z (mm)	
	Normal	Long				Normal	Long
63	FL30606P y	FL40606P y	102	75	60	92	95
75	FL30707P y	FL40707P y	122	89	66	110	120
90	FL30808P y	FL40808P y	138	105	78	125	140
110	FL30909P y	FL40909P y	158	125	100	120	160
125	FL31010P y	FL41010P y	158	132	114	120	170
140	FL31111P y	FL41111P y	188	155	127	152	200
160	FL31212P y	FL41212P y	212	175	151	155	200
180	FL31313P y	FL41313P y	212	180	158	171	199
200	FL31414P y	FL41414P y	268	232	203	193	199
225	FL31515P y	FL41515P y	268	235	210	200	200
250	FL31616P y	FL41616P y	320	285	245	204	204
280	FL31717P y	FL41717P y	320	291	265	171	210
315	FL31818P y	FL41818P y	370	335	300	173	210

Type B: with chamfer suitable for butterfly valve

• Consider y of product code as follow:

SDR	7.4	9	11	13.6	17
y	2	3	4	5	6

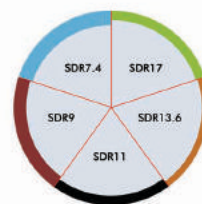

PP-Equal Tee 90°

PP-Литые Тройники Соединительные 90°

ISO 15494 | INSO 21266 | PP-R,PP-RCT

PP-T-Stück 90°

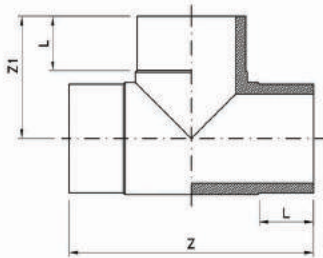

Nominal size (mm)	Code	Z (mm)	Z ₁ (mm)	L (mm)
63	T010606Py	221	106	60
75	T010707Py	248	124	72
90	T010808Py	247	136	70
110	T010909Py	317	159	85
125	T011010Py	290	147	67
140	T011111Py	375	194	35
160	T011212Py	400	200	102
180	T011313Py	466	234	107
200	T011414Py	450	239	108
225	T011515Py	454	262	102
250	T011616Py	517	282	101
280	T011717Py	601	324	101
315	T011818Py	596	299	125

• Consider y of product code as follow:

SDR	7.4	9	11	13.6	17
y	2	3	4	5	6

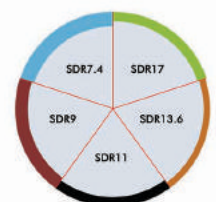

PP-Elbow 90°

PP-Литые Отвод 90°

PP-Winkel 90°

ISO 15494 | INSO 21266 | PP-R,PP-RCT

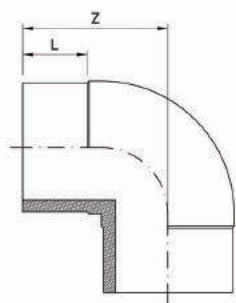

Nominal size (mm)	Code	Z (mm)	L (mm)
63	E020606Py	117	61
75	E020707Py	120	60
90	E020808Py	128	55
110	E020909Py	158	86
125	E021010Py	172	85
140	E021111Py	174	87
160	E021212Py	179	102
180	E021313Py	247	129
200	E021414Py	244	120
225	E021515Py	242	113
250	E021616Py	248	103
315	E021818Py	327	122

• Consider y of product code as follow:

SDR	7.4	9	11	13.6	17
y	2	3	4	5	6

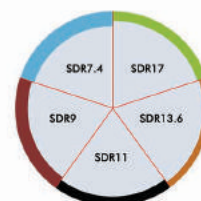

PP-Elbow 45°

PP-Литые Отвод 45°

ISO 15494 | INSO 21266 | PP-R,PP-RCT

PP-Winkel 45°

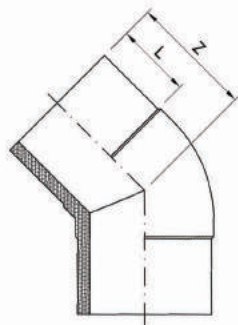

Nominal size (mm)	Code	Z (mm)	L (mm)
63	E010606Py	92	59
75	E010707Py	97	60
90	E010808Py	102	78
110	E010909Py	118	84
125	E011010Py	125	88.9
160	E011212Py	138	86
180	E011313Py	149	106
200	E011414Py	179	117
225	E011515Py	184	111
250	E011616Py	210	128
315	E011818Py	206	120

• Consider y of product code as follow:

SDR	7.4	9	11	13.6	17
y	2	3	4	5	6

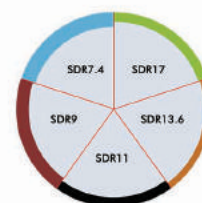

PP-Concentric Reducer Long spigot

PP-Литые Одноступенчатые Переходники

PP-Konzentrische Reduzierung, Lang

ISO 15494 | INSO 21266 | PP-R, PP-RCT

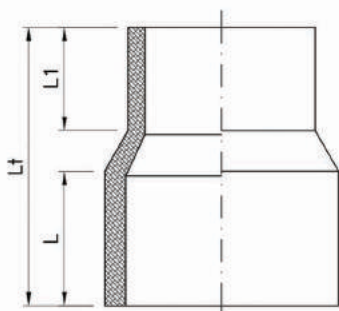

Nominal size (mm)	Code	L_1 (mm)	L (mm)	L_t (mm)
90×63	R010806Py	51	71	139
90×75	R010807Py	64.8	69	151
110×20	R010901Py	41	77	151
110×32	R010903Py	42	78	155
110×63	R010906Py	54	77	167
110×75	R010907Py	64	82	167
110×90	R010908Py	64	91	210
125×63	R011006Py	54	85	158
125×75	R011007Py	77	91	214
125×90	R011008Py	77	91	214
125×110	R011009Py	63	74	152
160×63	R011206Py	87	76	212
160×75	R011207Py	87	76	212
160×90	R011208Py	87	76	212
160×110	R011209Py	83	101	151
160×125	R011210Py	70	94	227
180×90	R011308Py	70	95	236
180×110	R011309Py	86	112	265
180×125	R011310Py	86	112	265
180×140	R011311Py	87	133	285
180×160	R011312Py	79	112	245

• Consider y of product code as follow:

SDR	7.4	9	11	13.6	17
y	2	3	4	5	6

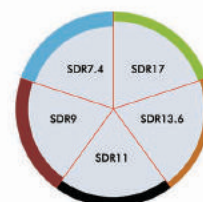

PP-Concentric Reducer Long spigot

PP-Литые Одноступенчатые Переходники

ISO 15494 | INSO 21266 | PP-R, PP-RCT

PP-Konzentrische Reduzierung, Lang

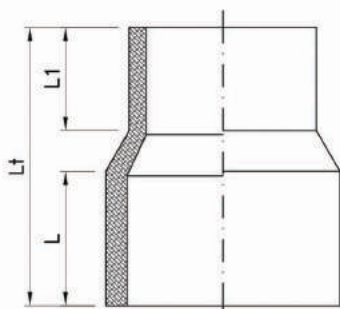

Nominal size (mm)	Code	L ₁ (mm)	L (mm)	L _t (mm)
200×90	R011408Py	82	112	263
200×110	R011409Py	85	114	260
200×125	R011410Py	88	101	248
200×140	R011411Py	88	133	285
200×160	R011412Py	867	133	285
200×180	R011413Py	88	133	285
225×63	R011506Py	80	115	287
225×75	R011507Py	80	115	287
225×90	R011508Py	80	115	287
225×110	R011509Py	80	115	287
225×125	R011510Py	80	115	287
225×140	R011511Py	80	115	287
225×160	R011512Py	80	115	287
225×180	R011513Py	91	142	286
225×200	R011514Py	91	142	286
250×90	R011608Py	85	120	285
250×110	R011609Py	85	120	285
250×160	R011612Py	80	115	287
250×180	R011613Py	96	126	299
250×200	R011614Py	91	142	286
315×160	R011812Py	95	150	486
315×200	R011814Py	96	154	390

• Consider y of product code as follow:

SDR	7.4	9	11	13.6	17
y	2	3	4	5	6

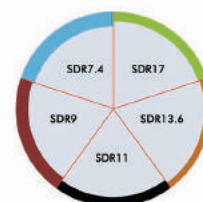

PP-Electrofusion Coupler

PP-Электросварные Муфты

PP-Heizwendel-Schweißmuffe

ISO 15494 | INSO 21266 | PP-R, PP-RCT

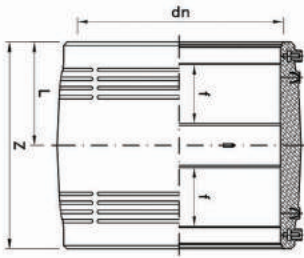

Nominal size (mm)	Code	L (mm)	f (mm)	Z (mm)
63	CU10606Py	47	17	95
75	CU10707Py	53	21	106
90	CU10808Py	61	29	123
110	CU10909Py	72	36	144
125	CU11010Py	78	39	157
160	CU11212Py	89	51	178
200	CU11414Py	103	57	206
225	CU11515Py	112	62	224
250	CU11616Py	117	61	234
315	CU11818Py	126	71	253

• Consider y of product code as follow:

SDR	7.4	9	11	13.6	17
y	2	3	4	5	6

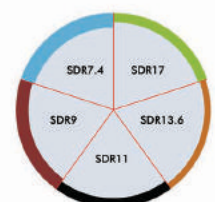

PP-Steel Backing Ring (PN16)

PP-Металлические Кольца

Flansch aus PP mit Stahleinlage
(nach EN1092-PN16)

EN1092-1

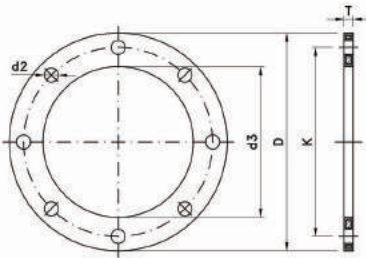

Flange Size (mm)	Code	D (mm)	d ₃ (mm)	K (mm)	d ₂ (mm)	Bolt Number	T (mm)
63	RL10620P4	165	78	125	18	4	18
75	RL10720P4	185	92	145	18	8	18
90	RL10820P4	200	108	160	18	8	20
110	RL10922P4	220	128	180	18	8	20
125	RL11022P4	220	135	180	18	8	22
160	RL11224P4	285	178	240	22	8	25
180	RL11324P4	285	188	240	22	8	25
200	RL11424P4	340	235	295	22	12	28
225	RL11524P4	340	238	295	22	12	28
250	RL11626P4	405	288	355	26	12	30
315	RL11826P4	460	338	410	26	12	35
355	RL11930P4	520	376	470	26	16	35
400	RL12032P4	580	430	525	30	16	40

Transition Fitting & Paddle Pipe

Муфты Комбинированные

ISO 4427 | INSO 14427 | HDPE 100

Übergangs-Nippel und
Einlegerohr mit Mittelpaddel

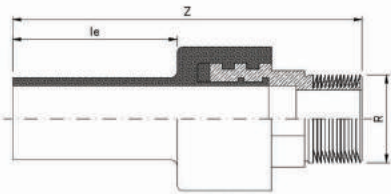

Nominal Size (mm)	Code	R (in)	le (mm)	Z _{min} (mm)
20	TF10101R y	1/2	40	85
25	TF10202R y	3/4	50	106
32	TF10303R y	1	50	115
40	TF10404R y	1 1/4	50	125
50	TF10505R y	1 1/2	55	130
63	TF10606R y	2	55	129



• Consider y of product code as follow:

SDR	11	17
y	4	6

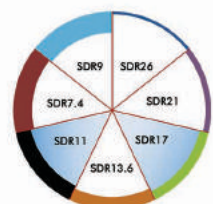

Schrauben und Muttern

Болты и Гайки

EN1092-1, ASME B16.5

Bolt & Nut



Backing Ring Size PE(mm)	EN 1092						ASME B16.5					
	Backing Ring Bolt Hole	Bolt Size	Qty.	Backing Ring Bolt Hole	Bolt Size	Qty.	Backing Ring Bolt Hole	Bolt Size	Qty.	Backing Ring Bolt Hole	Bolt Size (Inch)	Qty.
	PN10			PN16			PN25			Class 150		
63	18	M16	4	18	M16	4	18	M16	4	19.05	5/8	4
75	18	M16	8	18	M16	8	18	M16	8	19.05	5/8	4
90	18	M16	8	18	M16	8	18	M16	8	19.05	5/8	4
110	18	M16	8	18	M16	8	22	M20	8	19.05	5/8	8
125	18	M16	8	18	M16	8	22	M20	8	19.05	5/8	8
140	18	M16	8	18	M16	8	26	M24	8	22.22	3/4	8
160	22	M20	8	22	M20	8	26	M24	8	22.22	3/4	8
180	22	M20	8	22	M20	8	26	M24	8	22.22	3/4	8
200	22	M20	8	22	M20	12	26	M24	12	22.22	3/4	8
225	22	M20	8	22	M20	12	26	M24	12	22.22	3/4	8
250	22	M20	12	26	M24	12	30	M27	12	25.4	7/8	12
280	22	M20	12	26	M24	12	30	M27	12	25.4	7/8	12
315	22	M20	12	26	M24	12	30	M27	16	25.4	7/8	12
355	22	M20	16	26	M24	12	33	M30	16	28.57	1	12
400	26	M24	16	30	M27	16	36	M33	16	28.57	1	16
450	26	M24	20	30	M27	16	36	M33	20	31.75	1 1/8	16
500	26	M24	20	33	M30	20	36	M33	20	31.75	1 1/8	20
560	26	M24	20	33	M30	20	36	M33	20	31.75	1 1/8	20
630	30	M27	20	36	M33	20	39	M36	20	34.92	1 1/4	20

• According to Flange dimension order

Dichtungen

прокладк

HDPE 100

Gasket



Pipe Outside Diameter (mm)	Cod	d10 Outside of Gasket (mm)	Pipe Series(Inside Of Gasket) d9(mm)				b (mm)
			2	3	4	5	
20	GS1E01	45	-	-	-	16	2
25	GS1E02	58	-	-	21	20	2
32	GS1E03	68	-	-	28	26	2
40	GS1E04	78	-	36	35	33	2
50	GS1E05	88	-	46	44	41	2
63	GS1E06	102	59	58	56	51	2
75	GS1E07	122	70	69	66	61	2
90	GS1E08	138	84	83	80	74	2
110	GS1E09	158	103	101	97	90	3
125	GS1E10	158	117	115	111	102	3
140	GS1E11	188	131	129	124	114	3
160	GS1E12	212	150	148	142	131	3
180	GS1E13	212	169	166	160	147	3
200	GS1E14	268	188	185	177	164	3
225	GS1E15	268	211	208	199	184	3
250	GS1E16	320	234	231	222	204	3
280	GS1E17	320	263	258	248	229	3
315	GS1E18	370	295	291	279	258	3
355	GS1E19	430	333	328	315	290	3
400	GS1E20	482	375	369	355	327	3
450	GS1E21	585	422	415	399	368	3
500	GS1E22	585	469	461	443	409	3
560	GS1E23	685	525	517	497	456	3
630	GS1E24	685	590	581	559	513	3
710	GS1E25	800	666	655	630	-	3
800	GS1E26	905	750	738	709	-	3
900	GS1E27	1005	577	831	798	-	3
1000	GS1E28	1110	938	923	885	-	3
1200	GS1E29	1330	1126	1108	-	-	3

Collector

Коллекторы

HDPE 100

Kollektor



We are able to produce special fitting such as collectors and etc. according to customer order and technical plan.

Electrofusion Welding Machine Specification

Technical Data of electrofusion welding machine HST300 Print+2.0

- Welding PE, PP pipe and fittings
size: 20mm – 1200 mm



Automatic data logging	10,000 reports	Miscellaneous	intuitive report review menu incl. search, ViewWeld feature, memory backup, AutoWeld feature, buzzer volume set point, measurement unit selection (inches/mm, °F/°C)	
Welding range	Up to pipe & fittings size 1200mm		Languages	EN, DE, FR, BG, CS, ZH, NL, FI, GR, IT, NO, RO, SK, TR, RU,...
Data input	Barcode scanner, optionally scanning pen; manual input of fitting code sequence or welding voltage and time; optionally Fusamatic welding; all inputs also possible with novel GT keyboard			Production Standards and Approvals
Welding monitoring system	Welding voltage, resistance, welding current, established contact, short-circuit, ambient temperature, input frequency, input voltage, memory control, welding unit temperature, maintenance interval		Operation standards	
System self-monitoring	System check, computerized maintenance management, incl. recording			Output voltage
Traceability pursuant to ISO 12176-2/4	Commission number 32 alphanumeric characters, ISO compliant welder ID code, additional data 20 and 15 alphanumeric characters, ISO-compliant pipe data, fitting data, pipe length, weather conditions, installing company, joint number, inventory number, info on servicing company		Output current	Max. 110 A
Data output with menu	USB interface (USB A) for data download as an abstract or extended report in the PDF format to a USB stick or a label tag printer, with tag print menu;		Input voltage	180 V - 280 V
Display screen	Robust, hi-res temperature range-extended screen, character size 8 mm		Input frequency	40 Hz - 70 Hz
Weight	16 kg		Current consumption	AC 16 A
Dimensions	W 236 x H 295 x D 330 mm		Power rating	3500 W
Adaptor	4.0 mm in adapter bag	Recommended generator power	3.5 kVA	
		Temperature range	-20°C through +60°C	
		Power cord	5 m	
		Welding cable	4 m with 4.7 mm connection terminal	
		Automatic temperature compensation	Yes	
		Ingress protection	IP54	
		warranty	12 months	

1- Electrofusion welding

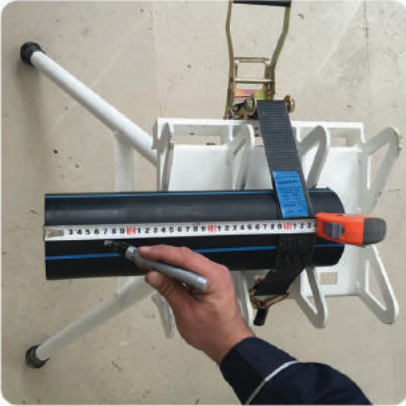

1-Measure area which has to be scraped with marker.

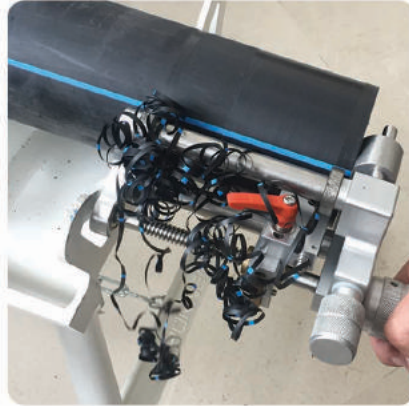

2- Scrape at last 0.2 mm of outside pipe surface to remove oxidation and other contaminants.



3- Clean pipe scraped area.
Note: do not touch the scraped area with bare hands after scraping and cleaning.

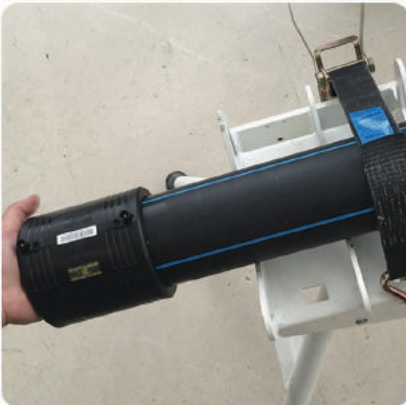

4-Insert pipe into electrofusion coupler.



5-Place second pipe end up to first pipe push electrofusion coupler back onto the second pipe until the second marking area with bare hands after scraping and cleaning.



6- Read barcode by scanner or light pen

2- Butt fusion welding

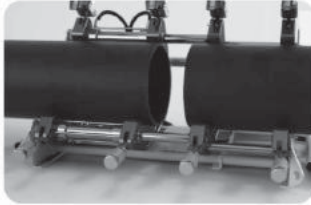

1. Place the pipes or fittings in the clamps .

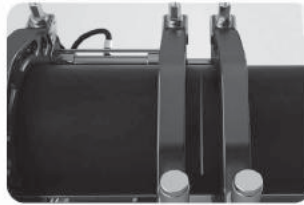

2. Check alignment .

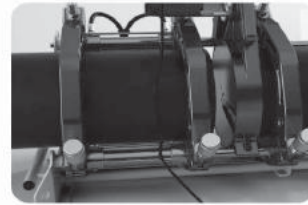

3. Place facing tool and start to cut surface or both pipes or fittings end .

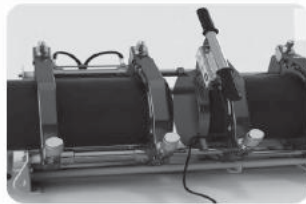

4. Place heater plate and apply pressure determined until a uniform bead formed on each end .

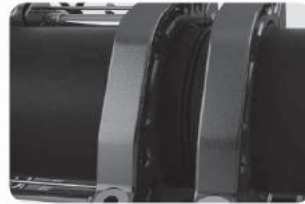

5. remove heater plate , close clamps to bring bead up .

3- Flanged Joint

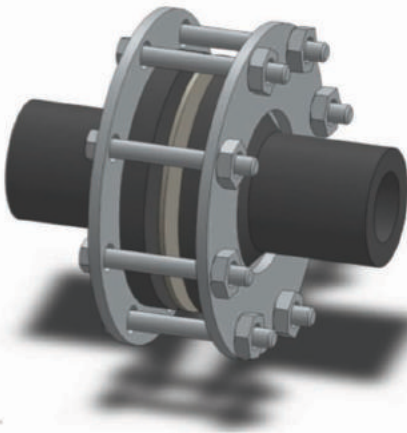

Type (A)

Flange with steel Backing Ring

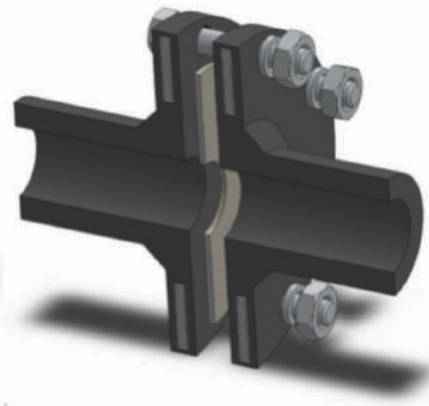
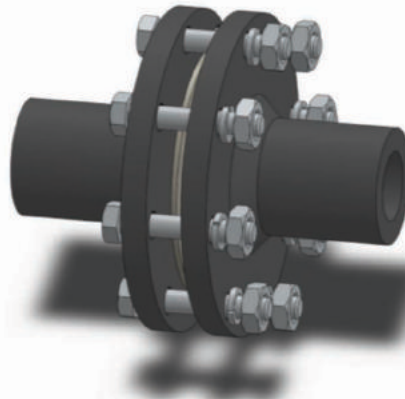

Type (B)

Steel Core Hole Flange

Advantage of Steel Core Hole Flange:

- 1- High Strength in comparing with backing ring due to using special material
- 2- No need to galvanized backing ring due to coating with polyethylene
- 3- Using shorter bolts in comparing with butt fusion polyethylene flange
- 4- Easy performance projects due to weigh less and reduction implementation time
- 5- Reduction of project cost

Welding techniques:

1 - Butt Welding

Butt-fusion jointing is a thermo-fusion process which involves the simultaneous heating of the ends of two Components which are to be joined until a melt state is attained on each contact surface. The two surfaces are then brought together under controlled pressure for a specific cooling time and homogeneous fusion is formed upon cooling. The resultant joint is resistant to end thrust and has comparable performance under pressure to the pipe.

This method of jointing requires an electrically heated plate to raise the temperature of the pipe ends to the required fusion temperature and is used for PE 80 and PE 100 grades of material for pipe of size 32 mm and above of the same Standard Dimension Ratio (SDR).

Remarks:

1) Dissimilar materials and dissimilar wall thicknesses can be joined by electrofusion. (Please note that the maximum working pressure should not exceed the lower of the two pipes.)

2) Similar material and/or wall thickness may be joined by Butt fusion or electrofusion. (Please note that SDR17 can be butt fused To SDR17.6)

3) Dissimilar wall thickness must not be joined by butt fusion.

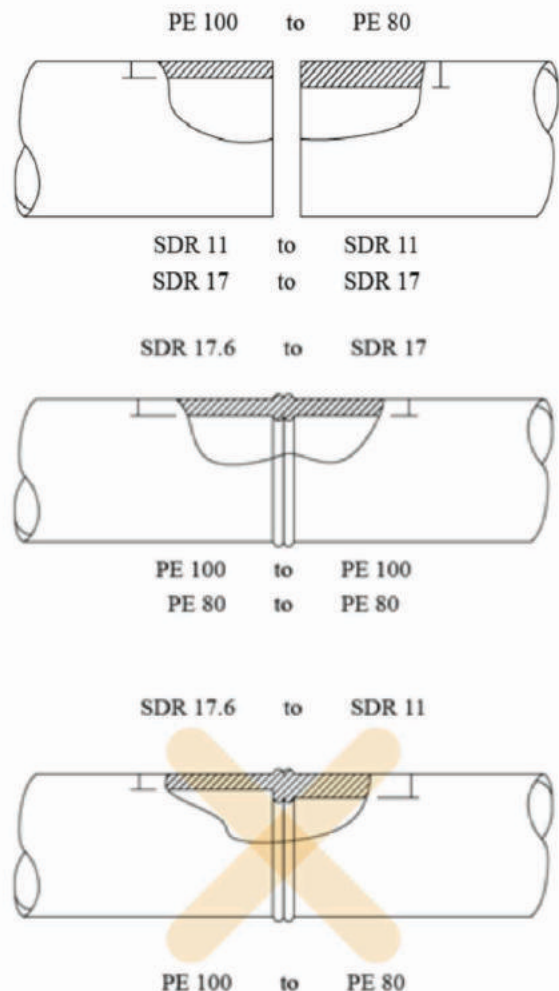

2- Electrofusion welding

The sectional drawings show the jointing sequence from energizing the coil until completion of fusion. The whole cycle is electronically monitored by the electrofusion control unit (ECU).

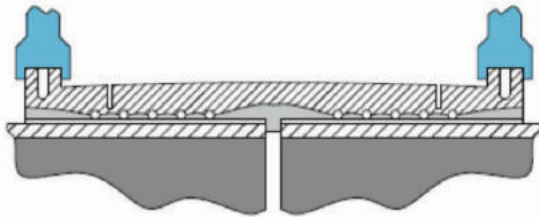

1. Pipe positioned in coupler prior to energising coil.

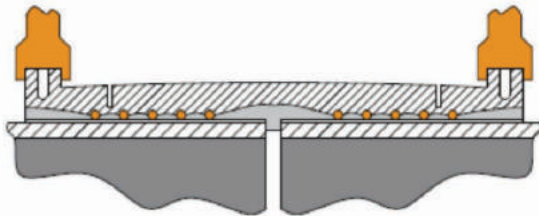

2. Coil energised.

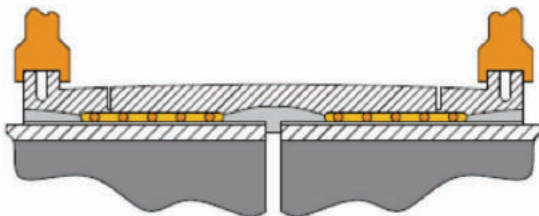

3. Material surrounding coil starts to melt.

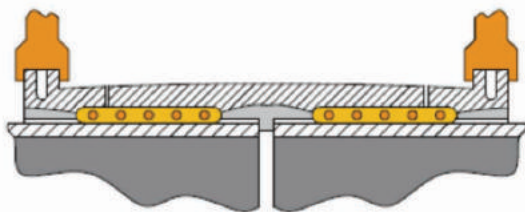

4. Area of melt extends leading to expansion towards pipe surface.

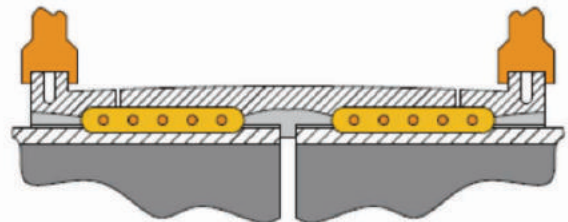

5. Heat transfers to pipe wall and material starts to melt

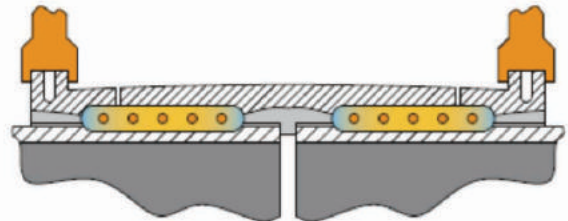

6. Melt solidifies at the start of the cold zones, thereby sealing the melt zone. Further input of energy causes increase in melt pressure.

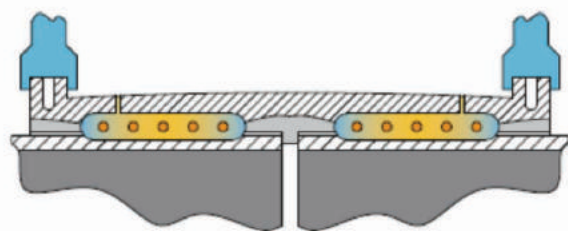

7. Melt pressure reaches optimum value at end of energising cycle. Emergence of the melt at the indicator holes shows that fusion is complete.

The material polyethylene (PE)

PE properties (reference values)

Property		Value	Unit	Test Method	Test Specimen
Density at 23°C		0.958	g/cm ³	ISO 1183	10mm x 10mm x 4mm
Viscosity Number		380	ml/g	ISO 1628-3	0.1% solution of granules in decahydronaphthalene
Melt Flow Rate	MFR 190/5	0.23	g/10min	ISO 1133	granules sample weight 3g to 6g
	MFR 190/21.6	6.5	g/10min		
Tensile Properties	Yield Stress	26	N/mm ²	ISO 527, Test Rate 50mm/min	ISO 3167, 4mm thick (test specimen no. 3, 4mm thick according to DIN 53 455)
	Elongation at Yield Stress	10	%	ISO 527, Test Rate 50mm/min	
	Tensile modulus of Elasticity (secant between 0.05 & 0.25% strain)	900	N/mm ²	ISO 527	
	Tensile Creep Modulus (1 hour value)	650	N/mm ²	ISO 899, Test Load 2M/mm ²	
	Tensile Creep Modulus (1000 hour Load 2M/mm ² value)	350	N/mm ²		
Flexural Properties	Flexural Creep Modulus (1 min value)	1100	N/mm ²	DIN 54852-Z4 $\sigma_b=2N/mm^2$	110mm x 10mm x 4mm loaded flat
	Flexural Stress (3.5%deflection)	20	N/mm ²	ISO 178, Test Rate 2mm/min	80mm x 10mm x 4mm
Stiffness in Torsion		180	N/mm ²	DIN 53447	60mm x 6.35mm x 3mm
Hardness	Ball Indentation Hardness	41	N/mm ²	ISO 2039 part 1 Test Load 132N	4mm sheet
	Shore Hardness D (3 sec value)	61	~	ISO 868	6mm sheet
	Shore Hardness D (15 sec value)	59	~		
Notched Impact Strength acN (test specimen from compression moulded sheet)	at 23°C	20	kJ/m ²	ISO 179/1eA	80mm x 10mm x 4mm
	at -30°C	10	kJ/m ²		
Vicat softening Point VST/B/50		67	°C	ISO 306	4mm sheet
Oxidation Induction Time	200°C in O ₂	>= 60	min	ISO TR 10837	granules

General

Polymers which consist only of carbon and hydrogen (hydrocarbons) are called polyolefin. Polyethylene (PE) belongs to this group. It is a semi crystalline thermoplastic. Polyethylene is the best known standard polymer.

The chemical formula is: $(CH_2-CH_2)_n$. It is an environmentally friendly hydrocarbon product.

PE and PP belong to the non-polar materials. Because of this, the material does not dissolve in common solvents and, in addition, hardly swells. As a result, PE pipes cannot be solvent cemented. The appropriate jointing method for this material is welding. For piping installations we offer two welding techniques in our product range: butt fusion and electrofusion.

The latter jointing technique is preferred for piping systems transporting gas, water, compressed air or other less aggressive media. Butt welding are preferably used on a diameter-specific basis. High molecular PE grades of medium to high density have become state of the art for industrial piping installations.

The Stress Regression Line

Numerous actual test results, measured at 20°C and 60°C, over a range of times up to 10,000 hours, are plotted on a log scale and a regression line is calculated to fit this data. The resultant regression line is then extrapolated to 50 years (438,000 hours). The method of calculation is an internationally accepted procedure described in ISO/TR 9080. The required values of stress and time are specified in ISO 4427.

The internationally accepted method for calculating circumferential hoop stress is derived from Barlow's formula and is as follows:

$$\sigma = p (d - e)/2e$$

where:

p = internal pressure (MPa)

e = minimum wall thickness (mm)

d = mean external diameter (mm)

σ = circumferential hoop stress in wall of pipe (MPa)

The Stress Regression Line for HDPE is given below.

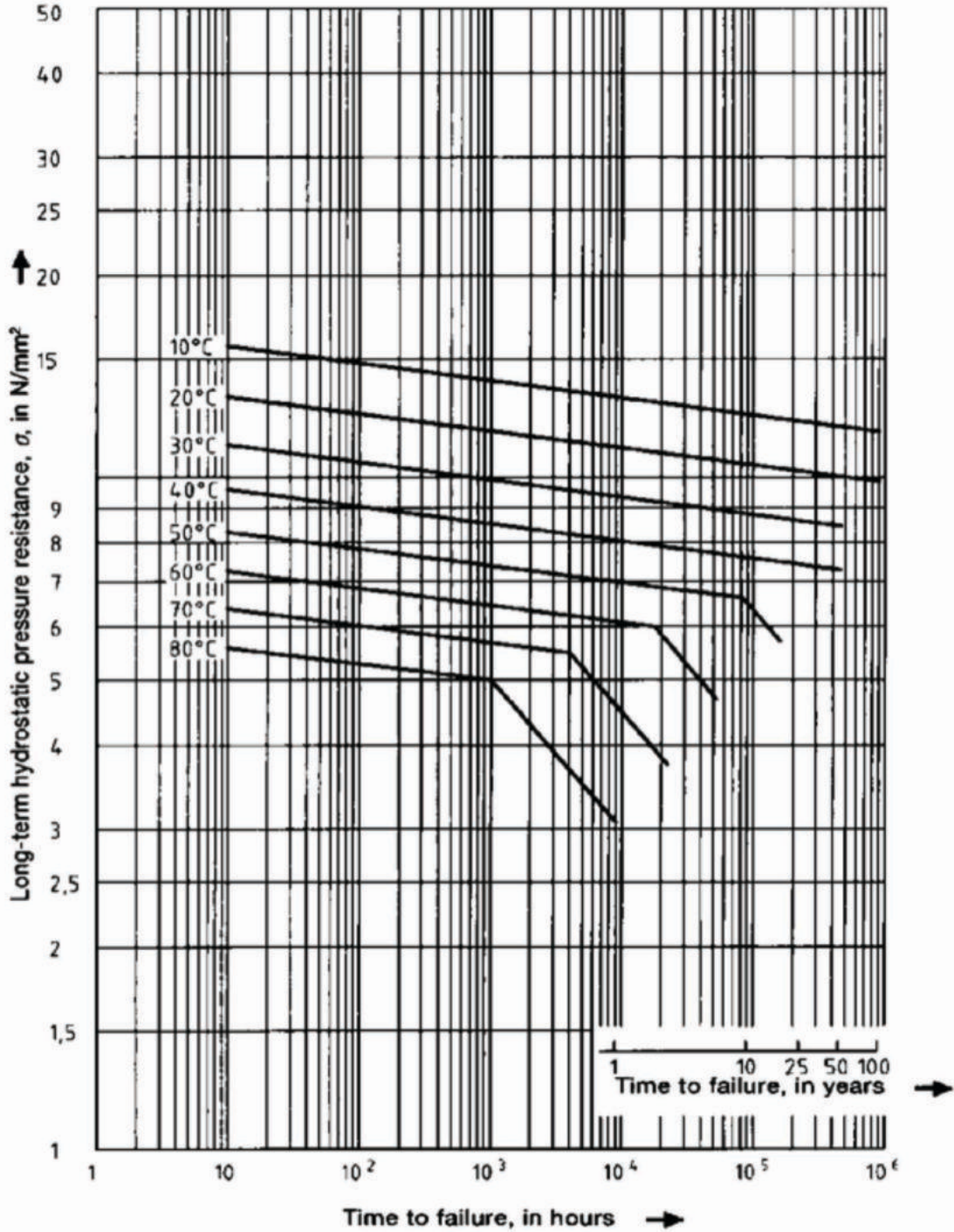

Figure 3: Long-term hydrostatic pressure resistance of pipes made from PE 100

INTRODUCTION OF PLASTICS

+ = Specimen is resistant swelling <3% or alternatively weight loss <0.5%, elongation of break not significantly changed

/ = Specimen has limited swelling 3-8% or alternatively weight resistance only loss 0.5-5% and/or elongation at break decreased by <50%

- = Specimen is not resistant swelling >8% or alternatively weight loss >5% and/or elongation a break decreased by >50%

D = discoloration

* = or at the boil

Substance	Polyethylene		
	Concentration	68°F	140°F
Acetic acid	100%	+	/D
Acetic acid, Aqueous	70%	+	+
Acetylene		+	
Alcohol		+	
Amino acids		+	+
Ammonium chloride, aqueous	all	+	+
Animal oils		+	/
Arsenic acid, aqueous	all	+	+
Benzoic acid, aqueous	all	+	+
Bromic acid	Conc.	-	
Butane, Gaseous		+	
Calcium hydroxide		+	+
Carbolic acid		+	+D
Carbon dioxide	100%	+	+
Chloral hydrate, aqueous	all	+	+D
Chloroacetic acid, aqueous	all	+	+
Chloroform	Tech. pure	/to-	-
Citric acid, aqueous	saturated	+	+
Ethanol	96%	+	+
Ethyl alcohol	96%	+	+
Ethyl ether	Tech. pure	+to/	/*
Ethylene oxide, gaseous	Tech. pure	+	+
Ferric chloride, aqueous	all	+	+
Formic acid, aqueous	85%	+	+
Fuel oil		+	/
Glycolic acid, aqueous	Up to 70%	+	+
Liquid paraffin		+	+
Machine oil		+	/
Malic acid, aqueous	50%	+	+
Methanol	Tech. pure	+	+
Methyl alcohol		+	+
Milk		+	+
Naphtha		+	/
Oxygen	all	+	+
Petrol	Tech. pure	+	+to/
Phosphoric acid, aqueous	80%...95%	+	/D
Polyglycols		+	+
Propanol		+	+
Pyridine		+	/
Sodium chlorate, aqueous	saturated	+	+
Sodium hydroxide, aqueous	all	+	+
Sulphuric acid, aqueous	Up to 50%	+	+
Sulphuric acid, aqueous	70%	+	+
Sulphuric acid, aqueous	80%	+	+
Sulphuric acid, aqueous	98%	/	-
Uric acid		+	+
Waxes		+	+to/

Thermal properties

Polyethylene pipes can be used at temperatures ranging from $-50\text{ }^{\circ}\text{C}$ to $+60\text{ }^{\circ}\text{C}$. Like all thermoplastics, PE shows a higher thermal expansion than metal. Our PE has a coefficient of linear thermal expansion of 0.15 to 0.20 mm/m K.

Electrical properties

Because of the low water absorption of PE, its electrical properties are hardly affected by continuous water contact. Since PE is a non-polar hydrocarbon polymer, it is an outstanding insulator. These properties, however, can be worsened considerably as a result of pollution, effects of oxidizing media or weathering. The specific volume resistance is $>10^{17}\text{ }\Omega\text{cm}$; the dielectric strength is 220 kV/mm.

Installation

The trench

al and regional regulations and directives for soil covered pipelines are to be followed during the construction of the necessary trench. The trench has to allow all parts of the pipeline to be in a frost-safe depth.

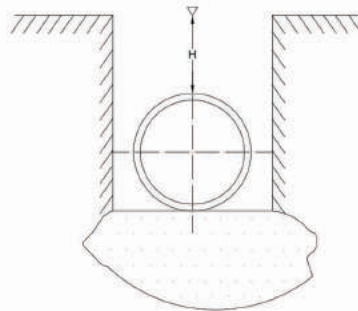

The base of the trench has to enable the pipeline to bear on smoothly. In case of bedrock the trench has to be excavated deeper and filled to the desired depth with appropriate material which grain size does not damage the pipe.

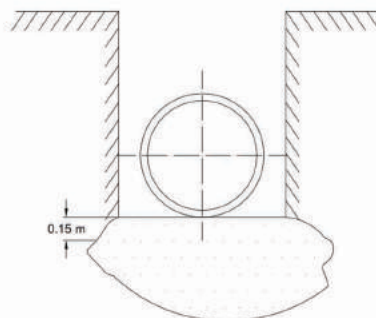

INTRODUCTION OF PLASTICS

The crucial factor to attain a good load capacity of pipes and fittings underground is a correct construction of the area around the pipe. The correct design of the pipe zone is determining the load capacity of PE pipes and fittings.

The pipe zone consists from bedding side fill and cover depth.

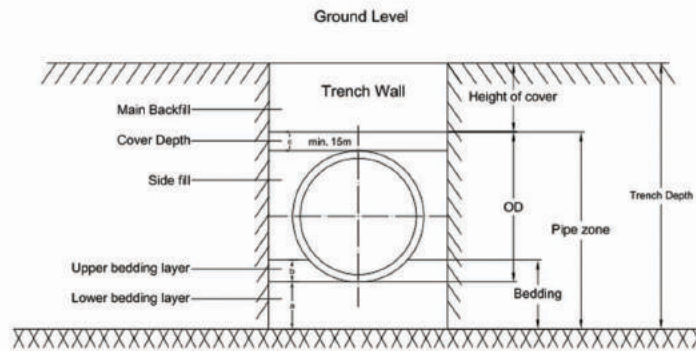

Usually, the minimum bedding is according to EN1610 $a = 100\text{mm}$, in case of bedrock or compacted

underground $a = 150\text{mm}$. Further, there are demands concerning the filling material. Materials with elements bigger than:

- 22 mm at $\text{DN} \leq 200$
- 40 mm at $\text{DN} > 200$ until $\text{DN} \leq 600$

should not be used.

The upper bedding layer b is assessed from static calculations.

It is important to assure no cavities below the pipe. The bedding dissipates all loads from the pipe evenly into the ground. For this reason the PE pipe has to lay evenly on the bedding over its complete length.

The upper end of the pipe zone is defined according to EN 1610 as 150mm above the pipe apex respectively 100mm above the pipe connection.

Long-term behavior of thermoplastic material

The most important characteristic of pressurized plastics is the pressure-time-behavior. This means the empirical and calculated life-time of pipes and parts of piping systems under depending boundary conditions such as inner pressure, temperature and time.

Calculation of allowed pressure/wall thickness

The technical design of pressurized thermoplastic pipes is carried out strictly according to strength requirements by means of the kesselformula. All pipe dimensions in standards are based on this formula. Deviations are just possible in smaller diameters since certain wall thicknesses will not under-run be due to practical and production limitations.

$$e = \frac{P \cdot d}{20 \cdot \sigma_{zul} + P}$$

Using:

e: wall thickness in mm

d: outer pipe diameter in mm

p: allowable pressure in bar

σ_{zul} : allowable stress in N/mm²

Simply using the nominal pressure is not enough anymore. The usual deployment of PN as a measure for the pipe size can harbour a danger of confusion regarding butt fusion. Plastic pipes and fittings equally pressure tolerable are meanwhile marked pressure-neutrally. The goal is to prevent a misuse of pipes in different application areas or different conditions. According to ISO 4065 pipes are classified into series. The series determines the load resistance without possibility of confusion as the nominal pressure did.

The pipe series is marked by the letter S. This series is based on the following formula:

$$S = \frac{10 \cdot \sigma_{zul}}{P \cdot C} = \frac{d - e}{2 \cdot e}$$

Consequently, S is dimensionless. For an PE-pipe with the dimensions 110 × 10 mm the formula yields $S = 5 = (110 - 10) / (2 \cdot 10)$.

Further the denotation SDR is known. SDR stands for Standard Dimension Ratio. SDR indicates the diameter/wall-thickness-ratio.

$$SDR = \frac{d}{e}$$

Series- and SDR are connected through the following formula:

$$SDR = 2 \times S + 1 \text{ or } S = (SDR - 1) / 2.$$

Using the upper example:

$$SDR = \frac{110}{10} = 11 = 2 \times 5 + 1$$

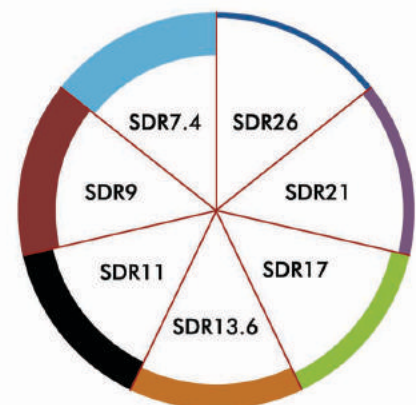

Currently all three indicators PN, S and SDR are used in the market. Takab Ettesal recommends to always stating dimension, wall-thickness and pipe series or SDR.

SDR	Pipe series S	Nominal Pressure PN
$\text{SDR} = d / e = 2 S + 1$	$S = \frac{d - e}{2 e}$	$PN = \frac{10 \sigma_s}{S}$
e.g.: SDR of 110/10 = 11	$S = \frac{100 - 10}{2 \times 10} = 5$	$PN = \frac{20 \sigma_s}{SDR - 1}$ $\sigma_s = \text{Designed stress}$

Required pipe diameter What size should the pipe be? Formulas

The following formula can be used for a first approximation of the pipe size required for a given flow rate:

$$d_i = 18.8 \sqrt{\frac{Q_1}{V}} \quad \text{OR} \quad d_i = 35.7 \sqrt{\frac{Q_2}{V}}$$

where:

v flow velocity in m/s

d_i inside pipe diameter in mm

Q₁ flow rate in m³/h

Q₂ flow rate in l/s

18.8 conversion factor for units

35.7 conversion factor for units

The flow velocity must first be approximated according to the intended use of the pipeline.

Standard values for the flow velocity are:

Liquids

v = 0.5-1.0 m/s for suction

v = 1.0-3.0 m/s for delivery

Gases

v = 10-30 m/s

The calculations of pipe diameter have not taken into account hydraulic losses. These require special calculations for which we offer the following information and recommendations.

Wall thicknesses and their tolerances

Dimensions in millimeter

Pipe Series															
		SDR 7.4		SDR 9		SDR 11		SDR 13.6		SDR 17		SDR 21		SDR 26	
		S 3.2		S 4.0		S 5		S 6.3		S 8		S 10		S 12.5	
		Nominal Pressure (PN) ^a bar													
PE 100		PN 25		PN 20		PN 16		PN 12.5		PN 10		PN 8		PN 6 ^c	
Nominal Size DN/OD		Wall thickness ^b mm													
		e _{min}	e _{max}	e _{min}	e _{max}	e _{min}	e _{max}	e _{min}	e _{max}	e _{min}	e _{max}	e _{min}	e _{max}	e _{min}	e _{max}
16		2.3 ^c	2.7	2.0 ^c	2.3	-	-	-	-	-	-	-	-	-	-
20		3.0	3.4	2.3 ^c	2.7	2.0 ^c	2.3	-	-	-	-	-	-	-	-
25		3.5	4.0	3.0	3.4	2.3 ^c	2.7	2.0 ^c	2.3	-	-	-	-	-	-
32		4.4	5.0	3.6	4.1	3.0	3.4	2.4	2.8	2.0 ^c	2.3	-	-	-	-
40		5.5	6.2	4.5	5.1	3.7	4.2	3.0	3.5	2.4	2.8	2.0 ^c	2.3	-	-
50		6.9	7.7	5.6	6.3	4.6	5.2	3.7	4.2	3.0	3.4	2.4	2.8	2.0	2.3
63		8.6	9.6	7.1	8.0	5.8	6.5	4.7	5.3	3.8	4.3	3.0	3.4	2.5	2.9
75		10.3	11.5	8.4	9.4	6.8	7.6	5.6	6.3	4.5	5.1	3.6	4.1	2.9	3.3
90		12.3	13.7	10.1	11.3	8.2	9.2	6.7	7.5	5.4	6.1	4.3	4.9	3.5	4.0
110		15.1	16.8	12.3	13.7	10.0	11.1	8.1	9.1	6.6	7.4	5.3	6.0	4.2	4.8
125		17.1	19.0	14.0	15.6	11.4	12.7	9.2	10.3	7.4	8.3	6.0	6.7	4.8	5.4
140		19.2	21.3	15.7	17.4	12.7	14.1	10.3	11.5	8.3	9.3	6.7	7.5	5.4	6.1
160		21.9	24.2	17.9	19.8	14.6	16.2	11.8	13.1	9.5	10.6	7.7	8.6	6.2	7.0
180		24.6	27.2	20.1	22.3	16.4	18.2	13.3	14.8	10.7	11.9	8.6	9.6	6.9	7.7
200		27.4	30.3	22.4	24.8	18.2	20.2	14.7	16.3	11.9	13.2	9.6	10.7	7.7	8.6
225		30.8	34.0	25.2	27.9	20.5	22.7	16.6	18.4	13.4	14.9	10.8	12.0	8.6	9.6
250		34.2	37.8	27.9	30.8	22.7	25.1	18.4	20.4	14.8	16.4	11.9	13.2	9.6	10.7
280		38.3	42.3	31.3	34.6	25.4	28.1	20.6	22.8	16.6	18.4	13.4	14.9	10.7	11.9
315		43.1	47.6	35.2	38.9	28.6	31.6	23.2	25.7	18.7	20.7	15.0	16.6	12.1	13.5
355		48.5	53.5	39.7	43.8	32.2	35.6	26.1	28.9	21.1	23.4	16.9	18.7	13.6	15.1
400		54.7	60.3	44.7	49.3	36.3	40.1	29.4	32.5	23.7	26.2	19.1	21.2	15.3	17.0
450		61.5	67.8	50.3	55.5	40.9	45.1	33.1	36.6	26.7	29.5	21.5	23.8	17.2	19.1
500		-	-	55.8	61.5	45.4	50.1	36.8	40.6	29.7	32.8	23.9	26.4	19.1	21.2
560		-	-	62.5	68.9	50.8	56.0	41.2	45.5	33.2	36.7	26.7	29.5	21.4	23.7
630		-	-	70.3	77.5	57.2	63.1	46.3	51.1	37.4	41.3	30.0	33.1	24.1	26.7

^a PN values are based on C=1,25

^b Tolerance in accordance with ISO 11922-1:1997, grade V, calculated from (1.5 e_{min} + 0,1) mm rounded up to the next 0,1 mm, for certain applications for e > 30mm, ISO 11922-1:1997, grade T, tolerance may be used calculated from 0,15 e_{min} rounded up to the next 0,1 mm.

^c The calculated value of e_{min} according to ISO 4065 is rounded up to the nearest value of the either 2,0, 2,3 or 3,0. This is to satisfy certain national requirements. For practical reasons, a wall thickness of 3,0 is recommended for electrofusion jointing and lining application.

According to standard EN 12201
ISO 4427
INSO 14427

Allowable working pressure of PE pipe lines for water supply

Temperature (C°)	Operating Period (years)	Diameter – wall thickness relation SDR						
		41	33	26	17	11	7.4	6
		Pipe series S						
		20	16	12.5	8	5	3.2	2.5
		PN						
		4	5	6.3	10	16	25	32
		Permissible component operating pressure p _s (bar)						
10	5	5.0	6.3	7.9	12.6	20.2	31.5	40.4
	10	4.9	6.2	7.8	12.4	19.8	31.0	39.7
	25	4.8	6.0	7.6	12.1	19.3	30.2	38.7
	50	4.7	5.9	7.5	11.9	19.0	29.7	38.0
	100	4.6	5.8	7.3	11.6	18.7	29.2	37.4
20	5	4.2	5.3	6.6	10.6	16.9	26.5	33.9
	10	4.1	5.2	6.5	10.4	16.6	26.0	33.3
	25	4.0	5.0	6.4	10.1	16.2	25.4	32.5
	50	4.0	5.0	6.3	10.0	16.0	25.0	32.0
	100	3.9	4.9	6.1	9.8	15.7	24.5	31.4
30	5	3.6	4.5	5.6	9.0	14.4	22.5	28.8
	10	3.5	4.4	5.5	8.8	14.1	22.1	28.3
	25	3.4	4.3	5.4	8.6	13.8	21.6	27.6
	50	3.3	4.2	5.3	8.4	13.5	21.2	27.1
40	5	3.0	3.8	4.8	7.7	12.3	19.3	24.7
	10	3.0	3.8	4.7	7.6	12.1	19.0	24.3
	25	2.9	3.7	4.6	7.4	11.8	18.5	23.7
	50	2.9	3.6	4.5	7.2	11.6	18.2	23.3
50	5	2.6	3.3	4.2	6.7	10.7	16.7	24.4
	10	2.6	3.2	4.0	6.5	10.4	16.2	20.3
	15	2.3	2.9	3.7	5.9	9.5	14.8	19.0
60	5	1.9	2.4	3.0	4.8	7.7	12.1	15.5
70	2	1.5	1.9	2.4	3.9	6.2	9.8	12.5

Physical characteristics of pipes

Characteristic	Requirements	Test parameters		Test method
Melt mass-flow rate (MFR)	When processing the material into a pipe, the MFR-value specified by the raw material producer may deviate at maximum $\pm 30\%$ compared with the raw material	Test temperature	230 °C	ISO 1133-1
		Loading mass or ^a	2,16 kg	
		Test temperature	190°C	
		Loading mass	5 kg	
Thermal stability tested by resistance to internal pressure at 110 °C	No failure during the test period	Material	Hydrostatic (hoop) stress MPa	ISO 1167-1 ISO 1167-2
		PP-R	1,9	
Longitudinal reversion	$\leq 2\%$	Temperature	135 °C	ISO 2505 Method B: Air oven
		PP-R		
		Immersion time:	1 h	
		$e \leq 8\text{ mm}$	2 h	
		$8\text{ mm} < e \leq 16\text{ mm}$	200 mm	
		Length of test pieces		

^a Alternative test method. In case of dispute, the test method agreed in the customer product specification with the raw material producer shall be used.

Physical characteristics of fittings

Characteristic	Requirements	Test parameters		Test method
Melt mass-flow rate (MFR)	Change of MFR by processing $\pm 30\%$	Test temperature	230 °C	ISO 1133-1
		Loading mass or ^a	2,16 kg	
		Test temperature	190 °C	
		Loading mass	5 kg	

^a Alternative test method. In case of dispute, the test method agreed in the customer product specification with the raw material producer shall be used.

PROLOGUE



Download link



No.1, Haqiqi Alley, Saduqi St. North Jamal Zadeh, Keshavarz Blvd. Tehran, Iran

Tel: +98 21 66947555-56 Fax: +98 21 66946738

www.takabplast.com | info@takabplast.com